

ACCESSORIES PRICE LIST 2021





From style, functionality, ease of installation to product material , our kitchen storage system offers an incredible range of design options.

Whether you are building or remodelling an existing space, we can help you to achieve the look and feel as you desired.

Our continuous research and development has created a perfect blend of ergonomic kitchen with functional accessories. We make your dream kitchen a very comfortable place to be.

With variety of product choices, we will help you through your design. It is our expertise in exploring your imagination and making your dream kitchen into reality!

CONTENT.....

SLIM BOX SERIES

- . DRAWER SET pg 7 ~ 8
- . INNER DRAWER SET pg 9 ~ 12
- . ADD ON ACCERISSIES pg 13

BENNO SERIES DRAWER SYSTEM

- . DRAWER SET pg 14 ~ 15
- . INNER DRAWER SET pg 16 ~ 20
- . ADD ON ACCERISSIE pg 21 ~ 31
- . UNDER MOUNT RUNNER pg 33 ~ 37
- . FULL EXTENTION SLIDE pg 38

DRAWER ORGANIZER SERIES

- . STAINLESS STEEL DRAWER ORGANIZER pg 40
- . CUTERY TRAY (M/GREY) pg 41 ~ 42

PREMIUM STORAGE SERIES

- . FOUR SIDE ALUMINIUM AND GLASS PULL OUT BASKET pg 44 ~ 45
- . THREE SIDE ALUMINIUM AND GLASS PULL OUT BASKET pg 46 ~ 47
- . ALUMINIUM AND GLASS MAGIC CORNER pg 48
- . ALUMINIUM AND GLASS BASE UNIT BASKET pg 49
- . ALUMINIUM AND GLASS 3 LAYER UTILITY PULL OUT pg 50
- . ALUMINIUM AND GLASS MAGIC COLECTOR pg 51
- . ALUMINIUM AND GLASS TALL UNIT pg 52 ~ 53

SOFT CLOSE CLASSIC STORAGE SERIES

- . SOFT CLOSE PULL OUT BASKET pg 56 ~ 57
- . SOFT CLOSE CONCARD CORNER KIT pg 58
- . SOFT CLOSE SMALL SIDE MOUNTED KIT pg 59
- . SOFT CLOSE CLEANING METRIAL BASKET pg 60
- . SOFT CLOSE SWING TRAY pg 61
- . SOFT CLOSE TALL LAEDER UNIT pg 62 ~ 63

.....CONTENT

CLASSIC STORAGE SERIES

- . PULL OUT BASKET pg 64 ~ 65
- . UTILITY PULL OUT BASKET pg 66 ~ 67
- . CLEANING MATERIAL PULL OUT BASKET pg 68
- . SPACE GENIE PULL OUT BASKET pg 69
- . SWIVER BASKET pg 70 ~ 71
- . DISH RACK pg 72 ~ 73

LIGHTNG SERIES

- . KITCHEN AND WARDROBE LIGHTING pg 74 ~ 84

WARDROBE SERIES

- . WARDROBE STORAGE pg 85 ~ 92

FITTING SERIES

- . KITCHEN FITTING ACCESSIRIES pg 93 ~ 108



A Perfect Blend For Kitchen

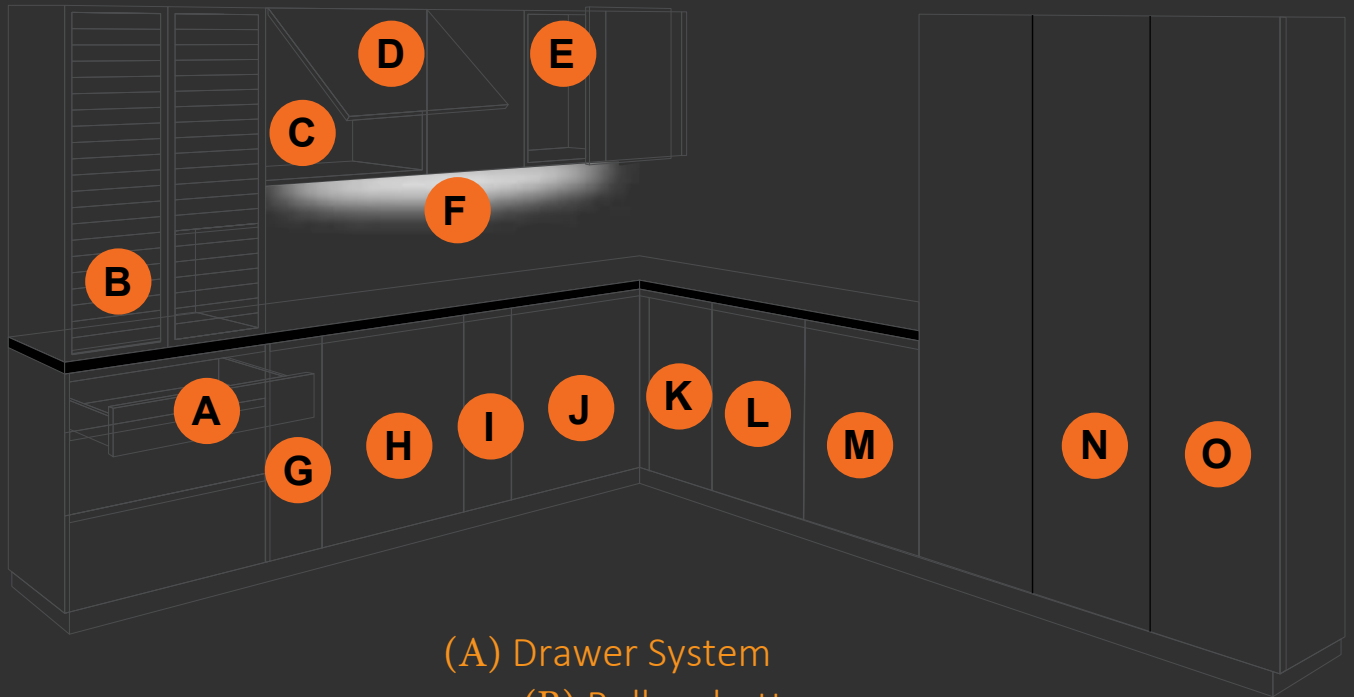

- (A) Drawer System
- (B) Roller shutter
- (C) Pull down Unit Li ter Basket
- (D) Lift-up System
- (CI) Tall Unit Sliding Door System
- (F) Lighting System
- (CII) Space Genie Pull Out Basket
- (CIII) Pull Out Waste Bin
- (I) Side Mounted Pull Out basket
- (J) Swing Tray
- (II) Utility 3 Layer Pull Out Basket
- (L) Pull Out Basket
- (M) Tall Unit Basket
- (LI) Alum. and Glass Deluxe Lardar
- (O) Inner Drawer System



SLIM BOX SERIES

Soft Close is a mechanism, which slows the close of a drawer as it is closed. The drawer is pushed back normally, when it reaches the last 25 mm of closure the soft close mechanism will act, and the door will slow immediately and then close gradually and silently. We launched three new soft close drawer systems to our Premium range from 2017. The first will be the Slim Box 88mm soft close drawer system which carries 30kg. It has standard Drawer with 90mm height, will install at top layer for base unit cabinet.

DS611 SLIM BOX 88MM

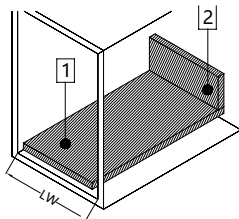

Technology pivot:
Bottom and Back Panel Measurement
16MM Density Panel

- 1 LW=Inside Cabinet Width
Bottom panel width=Inside Cabinet Width-75±0.5
Bottom panel length=Runner length-10mm
Back panel height= 68MM
- 2 Back panel width=Inside Cabinet Width-87±0.5



DS611-450 mm Slim Box

Model	1019 611 450
Basic Length	450 mm
Min Height	110 mm
Loading Capacity	30 KGS
List Price	RM 115.00

DS611-500 mm Slim Box

Model	1019 611 500 / DS611-500/50KG
Basic Length	500 mm
Min Height	110mm
Loading Capacity	30 KGS / 50KGS
List Price	RM 115.00 / RM 135

DS612 SLIM BOX 171MM

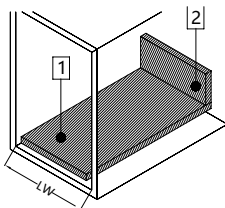

Technology pivot:
Bottom and Back Panel Measurement
16MM Density Panel

- 1 LW=Inside Cabinet Width
Bottom panel width=Inside Cabinet Width-75±0.5
Bottom panel length=Runner length-10mm
Back panel height= 151MM
- 2 Back panel width=Inside Cabinet Width-87±0.5



DS612-450 mm Slim Box

Model	1019 612 450
Basic Length	450 mm
Min Height	180 mm
Loading Capacity	30 KGS
List Price	RM 135.00

DS612-500 mm Slim Box

Model	1019 612 500 / DS612-500/50KG
Basic Length	500 mm
Min Height	180 mm
Loading Capacity	30 KGS / 50KGS
List Price	RM 135.00 / RM155.00

DS613 SLIM BOX 203MM

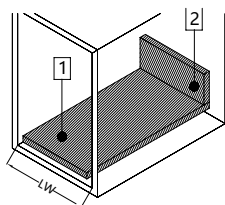

Technology pivot:
Bottom and Back Panel Measurement
16MM Density Panel

- 1 LW=Inside Cabinet Width
Bottom panel width=Inside Cabinet Width-75±0.5
Bottom panel length=Runner length-10mm
Back panel height=183MM
- 2 Back panel width=Inside Cabinet Width-87±0.5



DS613-450 mm Slim Box

Model	1019 613 450
Basic Length	450 mm
Min Height	210 mm
Loading Capacity	30 KGS
List Price	RM 150.00

DS613-500 mm Slim Box

Model	1019 613 500 / DS613-500/50KG
Basic Length	500 mm
Min Height	210 mm
Loading Capacity	30 KGS / 50 KGS
List Price	RM 150.00 / RM170.00

MUSE
Kitchen



SLIM SERIES INNER DRAWER

DS616 SLIM INNER BOX (STANDRAD)



DS616-450X600CG

Model	1019 616 061
Cabinet Width	600 mm
List Price	RM 159.00

DS616-500x600CG

Model	1019 616 062
Cabinet Width	600 mm
List Price	RM 159.00

DS616-450x900CG

Model	1019 616 091
Cabinet Width	900 mm
List Price	RM 176.00

DS616-500x900CG

Model	1019 616 092
Cabinet Width	900 mm
List Price	RM 176.00

DS616-450x1200CG

Model	1019 616 121
Cabinet Width	1200 mm
List Price	RM 193.00

DS616-500x1200CG

Model	1019 616 122
Cabinet Width	1200 mm
List Price	RM 193.00

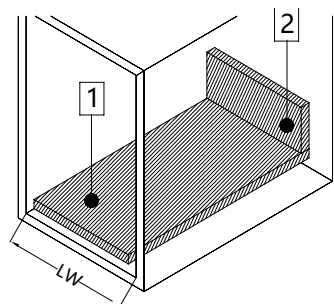

Technology pivot:
 Bottom and Back Panel Measurement
 16MM Density Panel

- 1** LW:Inside Cabinet Width
 Bottom panel width=Inside Cabinet Width-75±0.5
 Bottom panel length=Runner length-10mm
- 2** Back panel height= 68MM
 Back panel width=Inside Cabinet Width-87±0.5

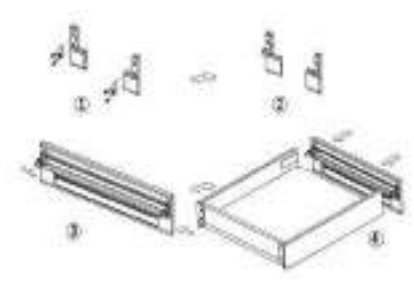

Model	Description	Length	List Price
DS-TS/450X1GS	DS-TS/450X1GS Drawer Body 450mm And Cover Cap for Slim Box	450 mm	RM 30.00
DS-TS/500X1GS	DS-TS/500X1GS Drawer Body 500mm And Cover Cap for Slim Box	500 mm	RM 30.00
DS-Q1/68CG	DS-Q1/68CG Back Connector Left/Right 68mm Charcoal Grey	~	RM 15.00
DSF-XM	DSF-XM Drawer Front Bracket	~	RM 10.00
1019 616 001	DSA301CG Front Panel Holder	~	RM11.00
1019 616 002	DSAQ311-600CG Front Panel 600mm	476 mm	RM33.00
1019 616 003	DSAQ311-900CG Front Panel 900mm	776 mm	RM50.00
1019 616 004	DSAQ311-1200CG Front Panel 1200mm	1076 mm	RM67.00

DS617 SLIM HIGH INNER DRAWER (WITH GLASS)

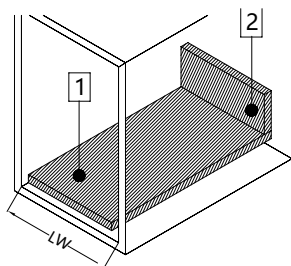

Technology pivot:
Bottom and Back Panel Measurement
16MM Density Panel

- 1** LW: Inside Cabinet Width
Bottom panel width=Inside Cabinet Width-75±0.5
Bottom panel length=Runner length-10mm
- 2** Back panel height=151MM
Back panel width=Inside Cabinet Width-87±0.5

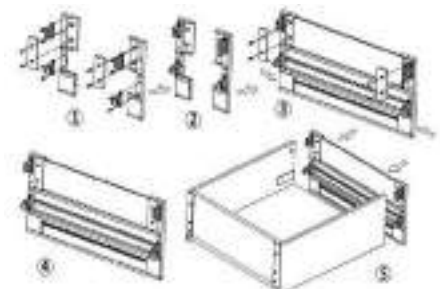

DS617-450X600CG

Model	1019 617 061
Cabinet Width	600 mm
List Price	RM 231.00

DS617-500x600CG

Model	1019 617 062
Cabinet Width	600 mm
List Price	RM 231.00

DS617-450x900CG

Model	1019 617 091
Cabinet Width	900 mm
List Price	RM 268.00

DS617-500x900CG

Model	1019 617 092
Cabinet Width	900 mm
List Price	RM 268.00

Model	Description	Lenght	List Price
DS-TS/450X3GS	DS-TS/450X3GS Drawer Body 450mm And Cover Cap for Slim Box	450 mm	RM 50.00
DS-TS/500X3GS	DS-TS/500X3GS Drawer Body 500mm And Cover Cap for Slim Box	500 mm	RM 50.00
DSF-XM	DSF-XM Drawer Front Bracket	~	RM 10.00
DSA303Q-07AF	DSA303Q-07AF Plastic Front Connector for Slim Box	~	RM11.00
1019 617 001	DSAQ305CG High Front Panel Holder with Glass Cover	~	RM 20.00
1019 616 002	DSAQ311-600CG Front Panel 600mm	476 mm	RM33.00
1019 616 003	DSAQ311-900CG Front Panel 900mm	776 mm	RM50.00
1019 616 004	DSAQ311-1200CG Front Panel 1200mm	1076 mm	RM67.00
1019 617 007	DSQ352-01-600CG Front Hightening Frosting Glass	600 mm	RM43.00
1019 617 008	DSQ352-01-900CG Front Hightening Frosting Glass	900 mm	RM63.00

DS618 SLIM HIGH INNER DRAWER (WITH RAIL)



Soft Closing
30KG Heavy Duty

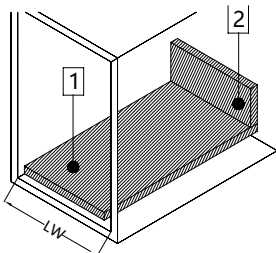

Technology pivot:
Bottom and Back Panel Measurement
16MM Density Panel

- 1** LW: Inside Cabinet Width
Bottom panel width = Inside Cabinet Width - 75 ± 0.5
Bottom panel length = Runner length - 10mm
- 2** Back panel height = 151MM
Back panel width = Inside Cabinet Width - 87 ± 0.5

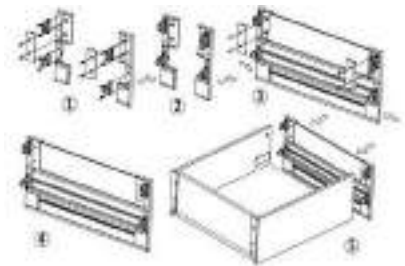

DS618-450X600CG

Model	1019 618 061
Cabinet Width	600 mm
List Price	RM 206.00

DS618-500x600CG

Model	1019 618 062
Cabinet Width	600 mm
List Price	RM 206.00

DS618-450x900CG

Model	1019 618 091
Cabinet Width	900 mm
List Price	RM 226.00

DS618-500x900CG

Model	1019 618 092
Cabinet Width	900 mm
List Price	RM 226.00

DS618-450x1200CG

Model	1019 618 121
Cabinet Width	1200 mm
List Price	RM 247.00

DS618-500x1200CG

Model	1019 618 122
Cabinet Width	1200 mm
List Price	RM 247.00

Model	Description	Lenght	List Price
DS-TS/450X2GS	DS-TS/450X2GS Drawer Body 450mm And Cover Cap for Slim Box	450 mm	RM 50.00
DS-TS/500X2GS	DS-TS/500X2GS Drawer Body 500mm And Cover Cap for Slim Box	500 mm	RM 50.00
DSF-XM	DSF-XM Drawer Front Bracket	~	RM 10.00
DSA303X-07AF	DSA303Q-07AF Plastic Front Connector for Slim Box	~	RM 11.00
1019 617 002	DSAQ315CG High Front Panel Holder with Rod Cover	~	RM 20.00
1019 616 002	DSAQ311-600CG Front Panel 600mm	476 mm	RM 33.00
1019 616 003	DSAQ311-900CG Front Panel 900mm	776 mm	RM 50.00
1019 616 004	DSAQ311-1200CG Front Panel 1200mm	1076 mm	RM 67.00
1019 618 001	DSAQ305-03-600CG Alum Handle 600mm	600 mm	RM 18.00
1019 618 064	DSAQ305-03-900CG Alum Handle 900mm	900 mm	RM 21.00
1019 618 063	DSAQ305-03-1200CG Alum Handle 1200mm	1200 mm	RM 25.00

Horizontal and Vertical Divider for SLIM BOX Series



DSCQ350-495 Horizontal Divider

Model	1019 001 060
Length	478mm
List Price	RM 40.00

DSDQ90CG Vertical Divider

Model	1019 003 001
Length	90 mm
List Price	RM 12.00

DSR/YMQ Square Shape Railing

Model	DSR/YMQ-500
Basic Length	500 mm
List Price	RM 18.00

DSCQ350-795 Horizontal Divider

Model	1019 001 090
Length	778 mm
List Price	RM 58.00

DSCQ350-1095 Horizontal Divider

Model	1019 001 120
Length	1078 mm
List Price	RM 74.00



BENNO SERIES SOFT CLOSE DRAWER SYSTEM

DS301N STANDARD DRAWER 86MM

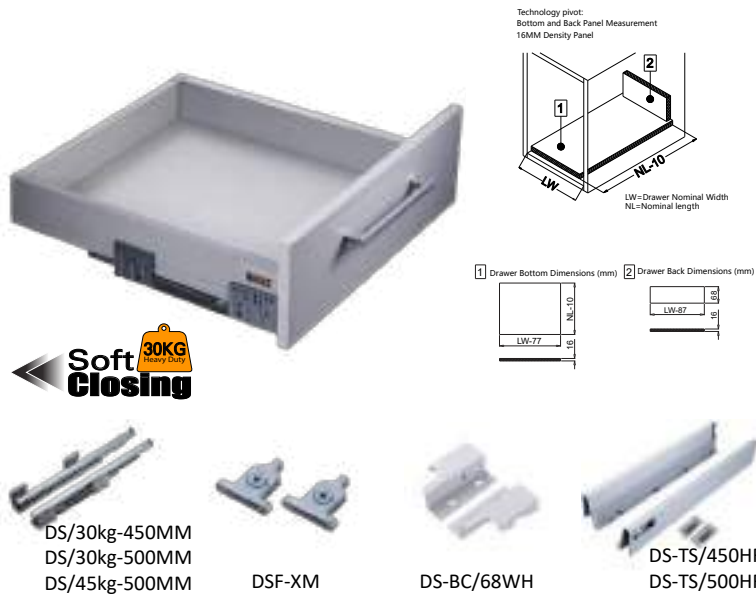

Technology pivot:
Bottom and Back Panel Measurement
16MM Density Panel

1 Drawer Bottom Dimensions (mm) 2 Drawer Back Dimensions (mm)

DS/30kg-450MM
DS/30kg-500MM
DS/45kg-500MM

DSF-XM DS-BC/68WH DS-TS/450HF DS-TS/500HF

Soft Closing 30KG Heavy Duty

DS301N-450WH Standard Drawer

Model	1025 301 450
Basic Length	450 mm
Min Height	115 mm
Loading Capacity	30 KGS
List Price	RM 110.00

DS301N-500WH Standard Drawer

Model	1025 301 500 / 1125 301 500
Basic Length	500 mm
Min Height	115 mm
Loading Capacity	30 KGS / 45KGS
List Price	RM 110.00 / RM120.00

DS302N HIGH DRAWER SINGLE GALLERY 142MM

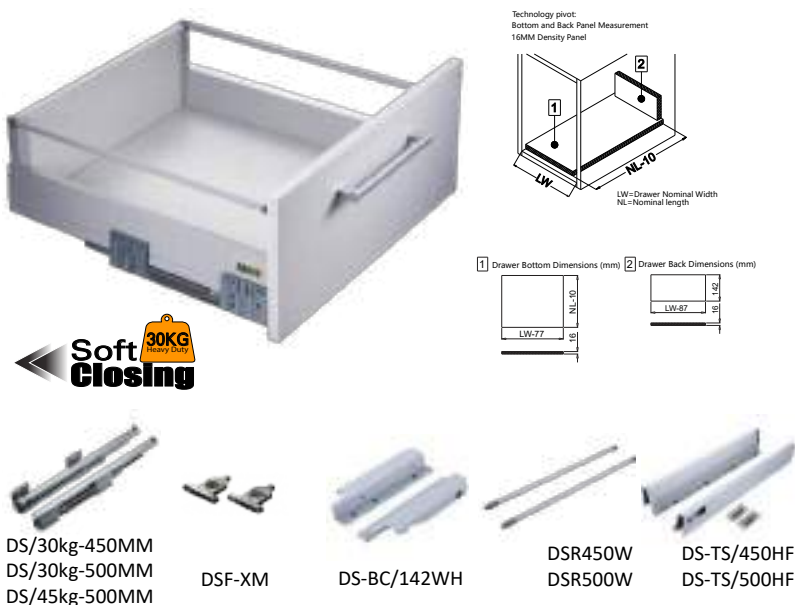

Technology pivot:
Bottom and Back Panel Measurement
16MM Density Panel

1 Drawer Bottom Dimensions (mm) 2 Drawer Back Dimensions (mm)

DS/30kg-450MM
DS/30kg-500MM
DS/45kg-500MM

DSF-XM DS-BC/142WH DSR450W DSR500W DS-TS/450HF DS-TS/500HF

Soft Closing 30KG Heavy Duty

DS302N-450WH High Drawe

Model	1025 302 450
Basic Length	450 mm
Min Height	182 mm
Loading Capacity	30 KGS
List Price	RM 128.00

DS302N-500WH High Drawe

Model	1025 302 500 / 1125 302 500
Basic Length	500 mm
Min Height	182 mm
Loading Capacity	30 KGS / 45 KGS
List Price	RM 128.00/ RM 138.00

DS304N HIGH DRAWER DUOUBLE GALLERY 185MM

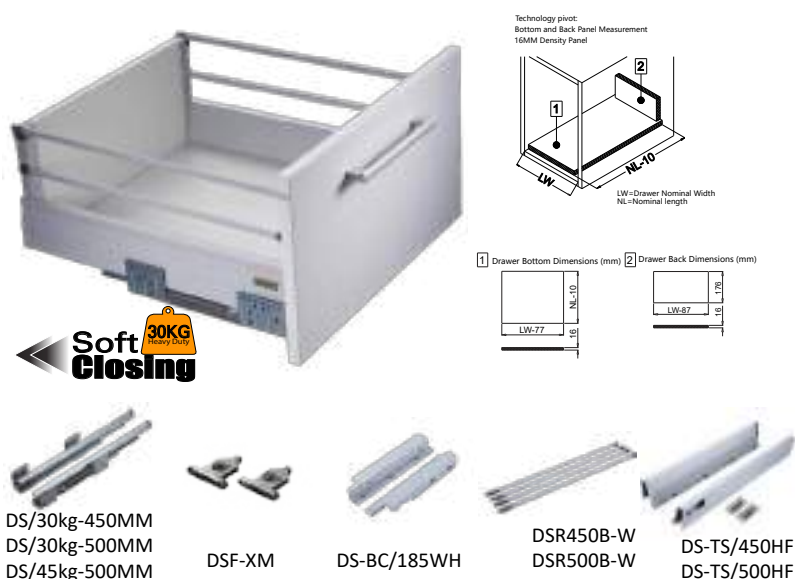

Technology pivot:
Bottom and Back Panel Measurement
16MM Density Panel

1 Drawer Bottom Dimensions (mm) 2 Drawer Back Dimensions (mm)

DS/30kg-450MM
DS/30kg-500MM
DS/45kg-500MM

DSF-XM DS-BC/185WH DSR450B-W DSR500B-W DS-TS/450HF DS-TS/500HF

Soft Closing 30KG Heavy Duty

DS304N-450WH High Drawe

Model	1025 304 450
Basic Length	450 mm
Min Height	227 mm
Loading Capacity	30 KGS
List Price	RM 146.00

DS304N-500WH High Drawe

Model	1025 304 500 / 1125 304 500
Basic Length	500 mm
Min Height	227 mm
Loading Capacity	30 KGS / 45 KGS
List Price	RM 146.00/ RM 156.00



BENNO SERIES INNER DRAWER SYSTEM

DS306 STANDRAD INNER DRAWER SYSTEM



Technology pivot:
Bottom and Back Panel Measurement
16MM Density Panel

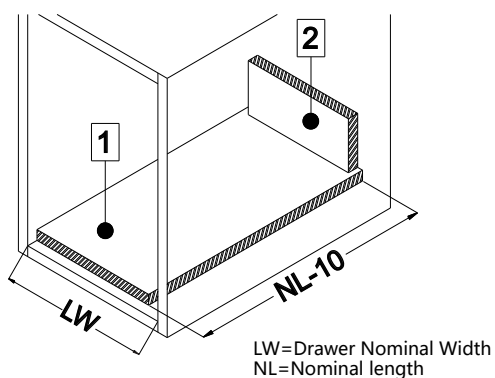

DS306-450x600WH

Model	1015 306 061
Cabinet Width	600 mm
Loading Capacity	30 KGS
List Price	RM 162.00

DS306-500x600WH

Model	1015 306 062 / 1115 306 062
Cabinet Width	600 mm
Loading Capacity	30 KGS / 45 KGS
List Price	RM 162.00 / RM 172.00

DS306-450x900WH

Model	1015 306 091
Cabinet Width	900 mm
Loading Capacity	30 KGS
List Price	RM 178.00

DS306-500x900WH

Model	1015 306 092 / 1115 306 092
Cabinet Width	900 mm
Loading Capacity	30 KGS / 45 KGS
List Price	RM 178.00 / RM 188.00

1 Drawer Bottom Dimensions (mm) 2 Drawer Back Dimensions (mm)

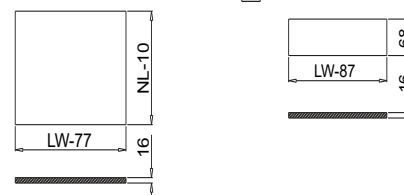

Inside a panel installation

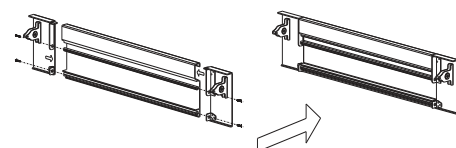

Model	Description	Lenght	List Price
1015 300 451	DS/30kg Drawer Runner Only 450mm	450 mm	RM 50.00
1015 300 501	DS/30kg Drawer Runner Only 500mm	500 mm	RM 50.00
1115 300 501	DS/45kg Drawer Runner Only 500mm	450 mm	RM 65.00
1015 301 001	DS-BC/68WH Rear Connector Left/Right 68mm White	~	RM 7.00
DS-TS/450HF	DS-TS/450HF Drawer Body And Cover Cup (White)	450 mm	RM 50.00
DS-TS/500HF	DS-TS/500HF Drawer Body And Cover Cup (White)	500 mm	RM 50.00
1015 306 001	DSA301WH Front Panel Holder White	~	RM18.00
1015 306 002	DSA311-463WH Front Panel 600mm White	600 mm	RM 34.00
1015 306 003	DSA311-763WH Front Panel 900mm White	900 mm	RM 50.00
1015 306 004	DSA311-1063WH Front Panel 1200mm White	1200 mm	RM 68.00

DS307 GLASS HIGH INNER DRAWER SYSTEM



Technology pivot:
Bottom and Back Panel Measurement
16MM Density Panel

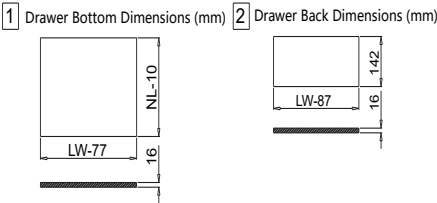
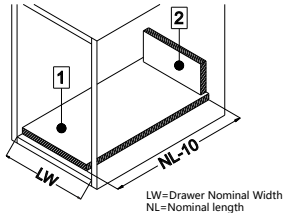

A panel and party in the armrest installation

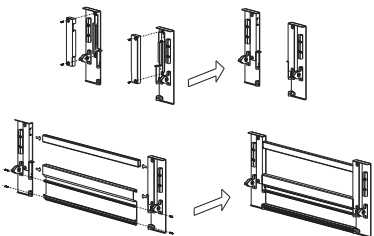

DS307-450x600WH	
Model	1015 307 061
Cabinet Width	600 mm
Loading Capacity	30 KGS
List Price	RM 345.00
DS307-500x600WH	
Model	1015 307 062 / 1115 307 062
Cabinet Width	600 mm
Loading Capacity	30 KGS / 45 KGS
List Price	RM 349.00 / RM 359.00
DS307-450x900WH	
Model	1015 307 091
Cabinet Width	900 mm
Loading Capacity	30 KGS
List Price	RM 382.00
DS307-500x900WH	
Model	1015 307 092 / 1115 307 092
Cabinet Width	900 mm
Loading Capacity	30 KGS / 45 KGS
List Price	RM 386.00 / RM 396.00

Model	Description	Lenght	List Price
1015 300 451	DS/30kg Drawer Runner Only 450mm	450 mm	RM 50.00
1015 300 501	DS/30kg Drawer Runner Only 500mm	500 mm	RM 50.00
1115 300 501	DS/45kg Drawer Runner Only 500mm	450 mm	RM 65.00
1015 307 002	DS-BC/176WH Rear Connector Left/Right 176mm White	~	RM 10.00
DS-TS/450HF	DS-TS/450HF Drawer Body And Cover Cup (White)	450 mm	RM 50.00
DS-TS/500HF	DS-TS/500HF Drawer Body And Cover Cup (White)	500 mm	RM 50.00
1015 307 111	DSA305N High Front Panel Holder White for Glass	~	RM 35.00
1015 306 002	DSA311-463WH Front Panel 600mm White	600 mm	RM 34.00
1015 306 003	DSA311-763WH Front Panel 900mm White	900 mm	RM 50.00
1015 306 004	DSA311-1063WH Front Panel 1200mm White	1200 mm	RM 68.00
1015 307 010	DSE450W Aluminium Slot Left/Right 450mm White	450 mm	RM 19.00
1015 307 003	DSE500W Aluminium Slot Left/Right 500mm White	500 mm	RM 21.00
1015 307 011	DS352-01-450 Side Panel Frosting Glass 450mm	450 mm	RM 85.00
1015 307 004	DS352-01-500 Side Panel Frosting Glass 500mm	500 mm	RM 87.00
1015 307 005	DSA305-03/04W Plastic Connector For Front Glass	~	RM 4.50
1015 307 006	DS352-02W Front And Rear Glass Clip Left/Right	~	RM 13.00
1015 307 007	DS352-01-600WM Front Hightening Frosting Glass 600mm	600 mm	RM 47.00
1015 307 008	DS352-01-900WM Front Hightening Frosting Glass 900mm	900 mm	RM 68.00

DS308 RAIL HIGH INNER DRAWER SYSTEM



DS308-450x600WH

Model	1015 318 061
Cabinet Width	600 mm
Loading Capacity	30 KGS
List Price	RM 313.00

DS308-500x600WH

Model	1015 318 062 / 1115 318 062
Cabinet Width	600 mm
Loading Capacity	30 KGS / 45 KGS
List Price	RM 315.00 / RM 325.00

DS308-450x900WH

Model	1015 318 091
Cabinet Width	900 mm
Loading Capacity	30 KGS
List Price	RM 331.00

DS308-500x900WH

Model	1015 318 092 / 1115 318 092
Cabinet Width	900 mm
Loading Capacity	30 KGS / 45 KGS
List Price	RM 335.00 / RM 345.00

Technology pivot:
Bottom and Back Panel Measurement
16MM Density Panel

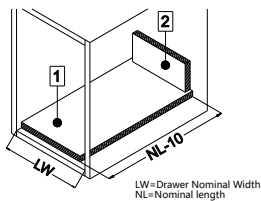

1 Drawer Bottom Dimensions (mm) 2 Drawer Back Dimensions (mm)

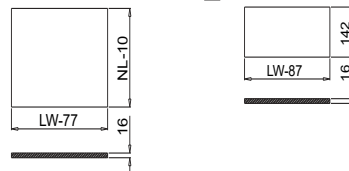

A panel and party in the armrest installation

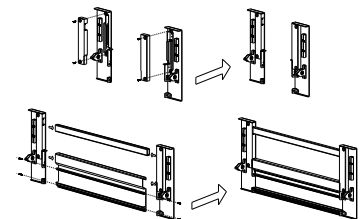

Model	Description	Length	List Price
1015 300 451	DS/30kg Drawer Runner Only 450mm	450 mm	RM 50.00
1015 300 501	DS/30kg Drawer Runner Only 500mm	500 mm	RM 50.00
1115 300 501	DS/45kg Drawer Runner Only 500mm	450 mm	RM 65.00
1015 307 002	DS-BC/176WH Rear Connector Left/Right 176mm White	~	RM 10.00
DS-TS/450HF	DS-TS/450HF Drawer Body And Cover Cup (White)	450 mm	RM 50.00
DS-TS/500HF	DS-TS/500HF Drawer Body And Cover Cup (White)	500 mm	RM 50.00
1015 307 001	DSA305WH High Front Panel Holder White for Railing	~	RM 27.00
1015 306 002	DSA311-463WH Front Panel 600mm White	600 mm	RM 34.00
1015 306 003	DSA311-763WH Front Panel 900mm White	900 mm	RM 50.00
1015 306 004	DSA311-11063WH Front Panel 1200mm White	1200 mm	RM 68.00
1015 307 010	DSE450W Aluminium Slot Left/Right 450mm White	450 mm	RM 19.00
1015 307 003	DSE500W Aluminium Slot Left/Right 500mm White	500 mm	RM 21.00
1015 307 011	DS352-01-450 Side Panel Frosting Glass 450mm	450 mm	RM 85.00
1015 307 004	DS352-01-500 Side Panel Frosting Glass 500mm	500 mm	RM 87.00
1015 307 005	DSA305-03/04W Plastic Connector For Front Glass	~	RM 4.50
1015 307 006	DS352-02W Front And Rear Glass Clip Left/Right	~	RM 13.00
1015 308 463	DSA305-03-463HW Alum Handle 463mm	600 mm	RM 13.00
1015 308 763	DSA305-03-763HW Alum Handle 763mm	900 mm	RM 17.00
1015 308 063	DSA305-03-1063HW Alum Handle 1063mm	1200 mm	RM 22.00

DS309 RAIL HIGH INNER DRAWER SYSTEM



Technology pivot:
Bottom and Back Panel Measurement
16MM Density Panel

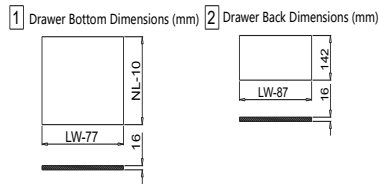
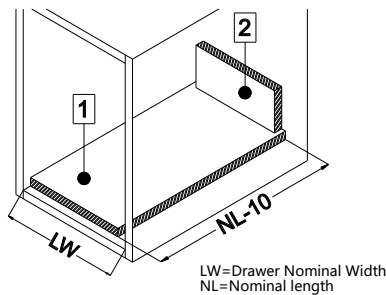

DS309-450x600WH

Model	1015 309 061
Cabinet Width	600 mm
Loading Capacity	30 KGS
List Price	RM 212.00

DS309-500x600WH

Model	1015 309 062 / 1115 309 062
Cabinet Width	600 mm
Loading Capacity	30 KGS / 45 KGS
List Price	RM 212.00 / RM 222.00

DS309-450x900WH

Model	1015 309 091
Cabinet Width	900 mm
Loading Capacity	30 KGS
List Price	RM 232.00

DS309-500x900WH

Model	1015 309 092 / 1115 309 092
Cabinet Width	900 mm
Loading Capacity	30 KGS / 45 KGS
List Price	RM 232.00 / RM 242.00

DS309-450x1200WH

Model	1015 309 121
Cabinet Width	1200 mm
Loading Capacity	30 KGS
List Price	RM 255.00

DS309-500x1200WH

Model	1015 309 122 / 1115 309 122
Cabinet Width	1200 mm
Loading Capacity	30 KGS / 45 KGS
List Price	RM 255.00 / RM 265.00

Model	Description	Length	List Price
1015 300 451	DS/30kg Drawer Runner Only 450mm	450 mm	RM50.00
1015 300 501	DS/30kg Drawer Runner Only 500mm	500 mm	RM50.00
1115 300 501	DS/45kg Drawer Runner Only 500mm	450 mm	RM 65.00
1015 307 002	DS-BC/176WH Rear Connector Left/Right 176mm White	~	RM 10.00
DS-TS/450HF	DS-TS/450HF Drawer Body And Cover Cup (White)	450 mm	RM 50.00
DS-TS/500HF	DS-TS/500HF Drawer Body And Cover Cup (White)	500 mm	RM 50.00
1015 307 001	DSA305WH High Front Panel Holder White for Railing	~	RM 27.00
1015 306 002	DSA311-600WH Front Panel 600mm White	600 mm	RM 34.00
1015 306 003	DSA311-900WH Front Panel 900mm White	900 mm	RM 50.00
1015 306 004	DSA311-1200WH Front Panel 1200mm White	1200 mm	RM 68.00
1015 308 463	DSA305-03-463HW Alum Handle 463mm	600 mm	RM 13.00
1015 308 763	DSA305-03-763HW Alum Handle 763mm	900 mm	RM 17.00
1015 308 063	DSA305-03-1063HW Alum Handle 1063mm	1200 mm	RM 22.00
1015 006 053	DSR450DWH Square Shape Railing for Inner Drawer 450mm	450 mm	RM 18.00
1015 006 052	DSR500DWH Square Shape Railing for Inner Drawer 500mm	500 mm	RM 18.00



BENNO SERIES ACCESSORIES SERIES SET

DS302 SERIES A SIDE ELEMENT SET



DS302-450 Series A Side Element Set

Model	1015 308 045
Cabinet Width	~
Loading Capacity	30 KGS
List Price	RM 167.00

DS302-500 Series A Side Element Set

Model	1015 308 050 / 1115 308 050
Cabinet Width	~
Loading Capacity	30 KGS / 45 KGS
List Price	RM 170.00 / RM 180.00



DS/30kg-450MM
DS/30kg-500MM
DS/45kg-500MM



DS-BC/142WH



DSF-XM



DSR450W
DSR500W



DS-TS/450HF
DS-TS/500HF



DS350-450mm
DS350-500mm

Technology pivot:
Bottom and Back Panel Measurement
16MM Density Panel

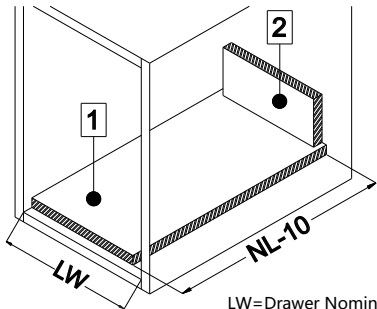

LW=Drawer Nominal Width
NL=Nominal length

1 Drawer Bottom Dimensions (mm) 2 Drawer Back Dimensions (mm)

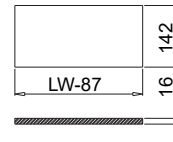
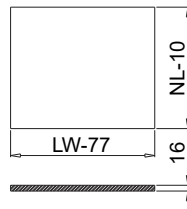

Model	Description	Lenght	List Price
1015 300 451	DS/30kg Drawer Runner Only 450mm	450 mm	RM 50.00
1015 300 501	DS/30kg Drawer Runner Only 500mm	500 mm	RM 50.00
1115 300 501	DS/45kg Drawer Runner Only 500mm	450 mm	RM 65.00
1015 301 501	DSF-XM Drawer Front Bracket	~	RM 10.00
1015 304 004	DS-BC/142WH Rear Connector Left/Right 142mm White	~	RM 15.00
1015 007 051	DSR450W Round Shape Railing for DS302-450mm	450 mm	RM 18.00
1015 007 052	DSR500W Round Shape Railing for DS302-500mm	500 mm	RM 18.00
DS-TS/450HF	DS-TS/450HF Drawer Body And Cover Cup (White)	450 mm	RM 50.00
DS-TS/500HF	DS-TS/500HF Drawer Body And Cover Cup (White)	500 mm	RM 50.00
1015 302 001	DS350-450mm Acrylic Heightening Plate 450mm	450 mm	RM 27.00
1015 302 002	DS350-500mm Acrylic Heightening Plate 500mm	500 mm	RM 34.00

DS304 SERIES A SIDE ELEMENT SET



DS304-450 Series A

Model	1015 313 045
Cabinet Width	~
Loading Capacity	30 KGS
List Price	RM 198.00

DS304-500 Series A

Model	1015 313 050 / 1115 313 050
Cabinet Width	~
Loading Capacity	30 KGS / 45 KGS
List Price	RM 201.00 / RM 211.00



DS/30kg-450MM
DS/30kg-500MM
DS/45kg-500MM

DS-BC/185WH

DSF-XM

DSR450B-W
DSR500B-W

DS-TS/450HF
DS-TS/500HF

DS351-450mm
DS351-500mm

Technology pivot:
Bottom and Back Panel Measurement
16MM Density Panel

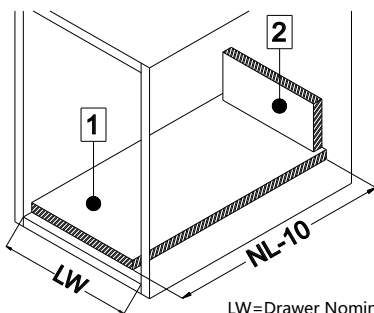

LW=Drawer Nominal Width
NL=Nominal length

1 Drawer Bottom Dimensions (mm) 2 Drawer Back Dimensions (mm)

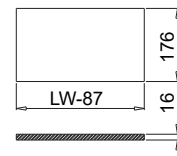
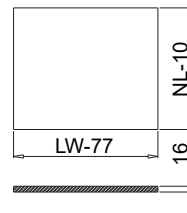

Model	Description	Lenght	List Price
1015 300 451	DS/30kg Drawer Runner Only 450mm	450 mm	RM 50.00
1015 300 501	DS/30kg Drawer Runner Only 500mm	500 mm	RM 50.00
1115 300 501	DS/45kg Drawer Runner Only 500mm	450 mm	RM 65.00
1015 301 501	DSF-XM Drawer Front Bracket	~	RM 10.00
1015 304 004	DS-BC/185WH Rear Connector Left/Right 185mm White	~	RM 20.00
1015 007 054	DSR450B-W Round Shape Railing for DS304-450mm	450 mm	RM 18.00
1015 007 053	DSR500B-W Round Shape Railing for DS304-500mm	500 mm	RM 18.00
DS-TS/450HF	DS-TS/450HF Drawer Body And Cover Cup (White)	450 mm	RM 50.00
DS-TS/500HF	DS-TS/500HF Drawer Body And Cover Cup (White)	500 mm	RM 50.00
1015 304 001	DS351-450mm Acrylic Heightening Plate 450mm	450 mm	RM 52.00
1015 304 002	DS351-500mm Acrylic Heightening Plate 500mm	500 mm	RM 55.00

DS302 SERIES B RAILING DIVIDER SET



DS/30kg-450MM
DS/30kg-500MM
DS/45kg-500MM



DS-BC/142WH



DSF-XM



DS340-450x600
DS340-500x600
DS340-450x900
DS340-500x900



DSR450W
DSR500W



DS-TS/450HF
DS-TS/500HF

Technology pivot:
Bottom and Back Panel Measurement
16MM Density Panel

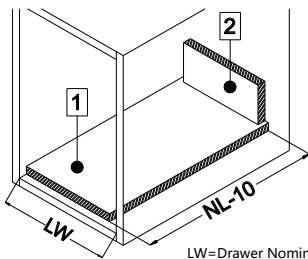

LW=Drawer Nominal Width
NL=Nominal length

DS302-450 x 600 Series B

Model	1015 309 145
Cabinet Width	600 mm
Loading Capacity	30 KGS
List Price	RM 180.00

DS302-500 x 600 Series B

Model	1015 309 150 / 1115 309 150
Cabinet Width	600 mm
Loading Capacity	30 KGS / 45 KGS
List Price	RM 180.00 / RM 190.00

DS302-450 x 900 Series B

Model	1015 309 245
Cabinet Width	900 mm
Loading Capacity	30 KGS
List Price	RM 182.00

DS302-500 x 900 Series B

Model	1015 309 250 / 1115 309 250
Cabinet Width	900 mm
Loading Capacity	30 KGS / 45 KGS
List Price	RM 182.00 / RM 192.00

1 Drawer Bottom Dimensions (mm) 2 Drawer Back Dimensions (mm)



Model	Description	Length	List Price
1015 300 451	DS/30kg Drawer Runner Only 450mm	450 mm	RM 50.00
1015 300 501	DS/30kg Drawer Runner Only 500mm	500 mm	RM 50.00
1115 300 501	DS/45kg Drawer Runner Only 500mm	450 mm	RM 65.00
1015 301 501	DSF-XM Drawer Front Bracket	~	RM 10.00
1015 304 004	DS-BC/142WH Rear Connector Left/Right 142mm White	~	RM 15.00
1015 007 051	DSR450W Round Shape Railing for DS302-450mm	450 mm	RM 18.00
1015 007 052	DSR500W Round Shape Railing for DS302-500mm	500 mm	RM 18.00
DS-TS/450HF	DS-TS/450HF Drawer Body And Cover Cup (White)	450 mm	RM 50.00
DS-TS/500HF	DS-TS/500HF Drawer Body And Cover Cup (White)	500 mm	RM 50.00
1015 004 060	DS340-450x600 Rails Divider 450mm(D) x 600mm(W)	600 mm	RM 52.00
1015 003 060	DS340-500x600 Rails Divider 500mm(D) x 600mm(W)	600 mm	RM 52.00
1015 004 060	DS340-450x900 Rails Divider 450mm(D) x 900mm(W)	900 mm	RM 54.00
1015 003 060	DS340-500x900 Rails Divider 500mm(D) x 900mm(W)	900 mm	RM 54.00

DS304 SERIES B RAILING DIVIDER SET



DS/30kg-450MM
DS/30kg-500MM
DS/45kg-500MM



DS-BC/142WH



DSF-XM



DS340-450x600
DS340-500x600
DS340-450x900
DS340-500x900



DSR450B-W
DSR500B-W



DS-TS/450HF
DS-TS/500HF

Technology pivot:
Bottom and Back Panel Measurement
16MM Density Panel

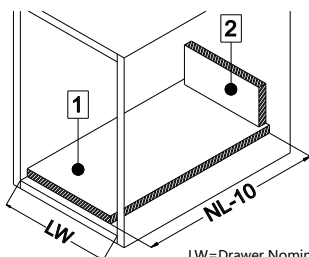

LW=Drawer Nominal Width
NL=Nominal length

DS304-450 x 600 Series B

Model	1015 314 145
Cabinet Width	600 mm
Loading Capacity	30 KGS
List Price	RM 198.00

DS304-500 x 600 Series B

Model	1015 314 150 / 1115 314 150
Cabinet Width	600 mm
Loading Capacity	30 KGS / 45 KGS
List Price	RM 198.00 / RM 208.00

DS304-450 x 900 Series B

Model	1015 314 245
Cabinet Width	900 mm
Loading Capacity	30 KGS
List Price	RM 200.00

DS304-500 x 900 Series B

Model	1015 314 250 / 1115 314 250
Cabinet Width	900 mm
Loading Capacity	30 KGS / 45 KGS
List Price	RM 200.00 / RM 210.00

1 Drawer Bottom Dimensions (mm) 2 Drawer Back Dimensions (mm)

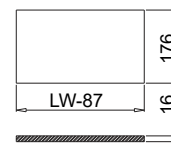
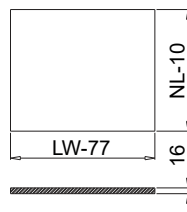

Model	Description	Length	List Price
1015 300 451	DS/30kg Drawer Runner Only 450mm	450 mm	RM 50.00
1015 300 501	DS/30kg Drawer Runner Only 500mm	500 mm	RM 50.00
1115 300 501	DS/45kg Drawer Runner Only 500mm	450 mm	RM 65.00
1015 301 501	DSF-XM Drawer Front Bracket	~	RM 10.00
1015 304 004	DS-BC/185WH Rear Connector Left/Right 185mm White	~	RM 20.00
1015 007 054	DSR450B-W Round Shape Railing for DS304-450mm	450 mm	RM 18.00
1015 007 053	DSR500B-W Round Shape Railing for DS304-500mm	500 mm	RM 18.00
DS-TS/450HF	DS-TS/450HF Drawer Body And Cover Cup (White)	450 mm	RM 50.00
DS-TS/500HF	DS-TS/500HF Drawer Body And Cover Cup (White)	500 mm	RM 50.00
1015 004 060	DS340-450x600 Rails Divider 450mm(D) x 600mm(W)	600 mm	RM 52.00
1015 003 060	DS340-500x600 Rails Divider 500mm(D) x 600mm(W)	600 mm	RM 52.00
1015 004 060	DS340-450x900 Rails Divider 450mm(D) x 900mm(W)	900 mm	RM 54.00
1015 003 060	DS340-500x900 Rails Divider 500mm(D) x 900mm(W)	900 mm	RM 54.00

DS302 SERIES C SIDE ELEMENT RAILING DIVIDER SET



DS/30kg-450MM
DS/30kg-500MM
DS/45kg-500MM

DS-BC/142WH

DSF-XM

DSR450W
DSR500W

DS-TS/450HF
DS-TS/500HF

DS350-450mm
DS350-500mm

DS340-450x600
DS340-500x600
DS340-450x900
DS340-500x900

Technology pivot:
Bottom and Back Panel Measurement
16MM Density Panel

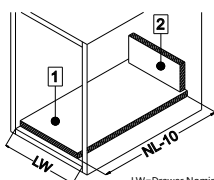

LW=Drawer Nominal Width
NL=Nominal length

DS302-450x600 Series C

Model	1015 310 145
Cabinet Width	600 mm
Loading Capacity	30 KGS
List Price	RM 219.00

DS302-500x600 Series C

Model	1015 310 150 / 1115 310 150
Cabinet Width	600 mm
Loading Capacity	30 KGS / 45 KGS
List Price	RM 222.00 / RM 232.00

DS302-450x900 Series C

Model	1015 310 245
Cabinet Width	900 mm
Loading Capacity	30 KGS
List Price	RM 221.00

DS302-500x900 Series C

Model	1015 310 250 / 1115 310 250
Cabinet Width	900 mm
Loading Capacity	30 KGS / 45 KGS
List Price	RM 224.00 / RM 234.00

1 Drawer Bottom Dimensions (mm) 2 Drawer Back Dimensions (mm)

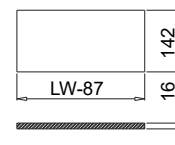
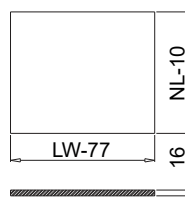

Model	Description	Length	List Price
1015 300 451	DS/30kg Drawer Runner Only 450mm	450 mm	RM 50.00
1015 300 501	DS/30kg Drawer Runner Only 500mm	500 mm	RM 50.00
1115 300 501	DS/45kg Drawer Runner Only 500mm	450 mm	RM 65.00
1015 301 501	DSF-XM Drawer Front Bracket	~	RM 10.00
1015 302 003	DS-BC/142WH Rear Connector Left/Right 142mm White	~	RM 15.00
1015 007 051	DSR450W Round Shape Railing for DS302-450mm	450 mm	RM 18.00
1015 007 052	DSR500W Round Shape Railing for DS302-500mm	500 mm	RM 18.00
DS-TS/450HF	DS-TS/450HF Drawer Body And Cover Cup (White)	450 mm	RM 50.00
DS-TS/500HF	DS-TS/500HF Drawer Body And Cover Cup (White)	500 mm	RM 50.00
1015 004 060	DS340-450x600 Rails Divider 450mm(D) x 600mm(W)	600 mm	RM 52.00
1015 003 060	DS340-500x600 Rails Divider 500mm(D) x 600mm(W)	600 mm	RM 52.00
1015 004 060	DS340-450x900 Rails Divider 450mm(D) x 900mm(W)	900 mm	RM 54.00
1015 003 060	DS340-500x900 Rails Divider 500mm(D) x 900mm(W)	900 mm	RM 54.00
1015 302 001	DS350-450mm Acrylic Heightening Plate 450mm	450 mm	RM 39.00
1015 302 002	DS350-500mm Acrylic Heightening Plate 500mm	500 mm	RM 42.00

DS304 SERIES C SIDE ELEMENT RAILING DIVIDER SET



Technology pivot:
Bottom and Back Panel Measurement
16MM Density Panel

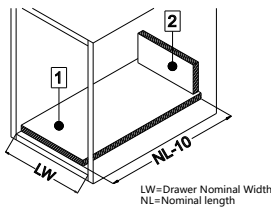

DS304-450x600 Series C

Model	1015 315 145
Cabinet Width	600 mm
Loading Capacity	30 KGS
List Price	RM 250.00

DS304-500x600 Series C

Model	1015 315 150 / 1115 315 150
Cabinet Width	600 mm
Loading Capacity	30 KGS / 45 KGS
List Price	RM 253.00 / RM 263.00

DS304-450x900 Series C

Model	1015 315 245
Cabinet Width	900 mm
Loading Capacity	30 KGS
List Price	RM 252.00

DS304-500x900 Series C

Model	1015 315 250 / 1115 315 250
Cabinet Width	900 mm
Loading Capacity	30 KGS / 45 KGS
List Price	RM 255.00 / RM 265.00

1 Drawer Bottom Dimensions (mm) 2 Drawer Back Dimensions (mm)

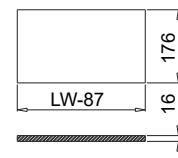

Model	Description	Length	List Price
1015 300 451	DS/30kg Drawer Runner Only 450mm	450 mm	RM 50.00
1015 300 501	DS/30kg Drawer Runner Only 500mm	500 mm	RM 50.00
1115 300 501	DS/45kg Drawer Runner Only 500mm	450 mm	RM 65.00
1015 301 501	DSF-XM Drawer Front Bracket	~	RM 10.00
1015 304 004	DS-BC/185WH Rear Connector Left/Right 185mm White	~	RM 20.00
1015 007 054	DSR450B-W Round Shape Railing for DS304-450mm	450 mm	RM 18.00
1015 007 053	DSR500B-W Round Shape Railing for DS304-500mm	500 mm	RM 18.00
DS-TS/450HF	DS-TS/450HF Drawer Body And Cover Cup (White)	450 mm	RM 50.00
DS-TS/500HF	DS-TS/500HF Drawer Body And Cover Cup (White)	500 mm	RM 50.00
1015 004 060	DS340-450x600 Rails Divider 450mm(D) x 600mm(W)	600 mm	RM 52.00
1015 003 060	DS340-500x600 Rails Divider 500mm(D) x 600mm(W)	600 mm	RM 52.00
1015 004 060	DS340-450x900 Rails Divider 450mm(D) x 900mm(W)	900 mm	RM 54.00
1015 003 060	DS340-500x900 Rails Divider 500mm(D) x 900mm(W)	900 mm	RM 54.00
1015 302 001	DS350-450mm Acrylic Heightening Plate 450mm	450 mm	RM 39.00
1015 302 002	DS350-500mm Acrylic Heightening Plate 500mm	500 mm	RM 42.00



Technology pivot:
Bottom and Back Panel Measurement
16MM Density Panel

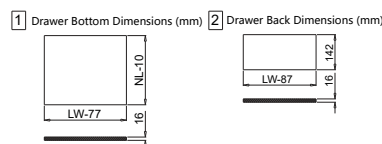
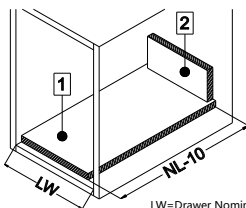

DS302-450x600 Series D

Model	1015 311 145
Cabinet Width	600 mm
Loading Capacity	30 KGS
List Price	RM 215.00

DS302-500x600 Series D

Model	1015 311 150 / 1115 311 150
Cabinet Width	600 mm
Loading Capacity	30 KGS / 45 KGS
List Price	RM 215.00 / RM 225.00

DS302-450x900 Series D

Model	1015 311 245
Cabinet Width	900 mm
Loading Capacity	30 KGS
List Price	RM 227.00

DS302-500x900 Series D

Model	1015 311 250 / 1115 311 250
Cabinet Width	900 mm
Loading Capacity	30 KGS / 45 KGS
List Price	RM 227.00 / RM 237.00

DS302-450x1200 Series D

Model	1015 311 345
Cabinet Width	1200 mm
Loading Capacity	30 KGS
List Price	RM 251.00

DS302-500x1200 Series D

Model	1015 311 350 / 1115 311 350
Cabinet Width	1200 mm
Loading Capacity	30 KGS / 45 KGS
List Price	RM 251.00 / RM 261.00

Model	Description	Length	List Price
1015 300 451	DS/30kg Drawer Runner Only 450mm	450 mm	RM 50.00
1015 300 501	DS/30kg Drawer Runner Only 500mm	500 mm	RM 50.00
1115 300 501	DS/45kg Drawer Runner Only 500mm	450 mm	RM 65.00
1015 301 501	DSF-XM Drawer Front Bracket	~	RM 10.00
1015 302 003	DS-BC/142WH Rear Connector Left/Right 142mm White	~	RM 15.00
1015 007 051	DSR450W Round Shape Railing for DS302-450mm	450 mm	RM 18.00
1015 007052	DSR500W Round Shape Railing for DS302-500mm	500 mm	RM 18.00
DS-TS/450HF	DS-TS/450HF Drawer Body And Cover Cup (White)	450 mm	RM 50.00
DS-TS/500HF	DS-TS/500HF Drawer Body And Cover Cup (White)	500 mm	RM 50.00
1015 001 060	DSC350-478 Horizontal Divider 600mm	600 mm	RM 24.00
1015 001 090	DSC350-778 Horizontal Divider 900mm	900 mm	RM 30.00
1015 001 120	DSC350-1078 Horizontal Divider 1200mm	1200 mm	RM 42.00
1015 002 001	DSD90W Vertical Divider	~	RM 13.00

DS304 SERIES D HORIZONTAL DIVIDER SET



Technology pivot:
Bottom and Back Panel Measurement
16MM Density Panel

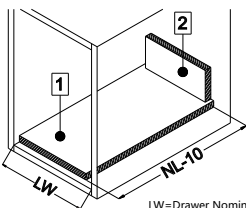

LW=Drawer Nominal Width
NL=Nominal length

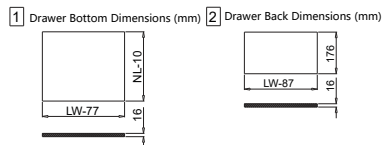

DS302-450x600 Series D

Model	1015 316 145
Cabinet Width	600 mm
Loading Capacity	30 KGS
List Price	RM 233.00

DS304-500x600 Series D

Model	1015 316 150 / 1115 316 150
Cabinet Width	600 mm
Loading Capacity	30 KGS / 45 KGS
List Price	RM 233.00 / RM 243.00

DS304-450x900 Series D

Model	1015 316 245
Cabinet Width	900 mm
Loading Capacity	30 KGS
List Price	RM 245.00

DS304-500x900 Series D

Model	1015 316 250 / 1115 316 250
Cabinet Width	900 mm
Loading Capacity	30 KGS / 45 KGS
List Price	RM 245.00 / RM 251.00

DS304-450x1200 Series D

Model	1015 316 345
Cabinet Width	1200 mm
Loading Capacity	30 KGS
List Price	RM 269.00

DS304-500x1200 Series D

Model	1015 316 350 / 1115 316 350
Cabinet Width	1200 mm
Loading Capacity	30 KGS / 45 KGS
List Price	RM 269.00 / RM 279.00

Model	Description	Length	List Price
1015 300 451	DS/30kg Drawer Runner Only 450mm	450 mm	RM 50.00
1015 300 501	DS/30kg Drawer Runner Only 500mm	500 mm	RM 50.00
1115 300 501	DS/45kg Drawer Runner Only 500mm	450 mm	RM 65.00
1015 301 501	DSF-XM Drawer Front Bracket	~	RM 10.00
1015 304 004	DS-BC/185WH Rear Connector Left/Right 185mm White	~	RM 20.00
1015 007 054	DSR450B-W Round Shape Railing for DS304-450mm	450 mm	RM 18.00
1015 007 053	DSR500B-W Round Shape Railing for DS304-500mm	500 mm	RM 18.00
DS-TS/450HF	DS-TS/450HF Drawer Body And Cover Cup (White)	450 mm	RM 50.00
DS-TS/500HF	DS-TS/500HF Drawer Body And Cover Cup (White)	500 mm	RM 50.00
1015 001 060	DSC350-478 Horizontal Divider 600mm	600 mm	RM 24.00
1015 001 090	DSC350-778 Horizontal Divider 900mm	900 mm	RM 30.00
1015 001 120	DSC350-1078 Horizontal Divider 1200mm	1200 mm	RM 42.00
1015 002 001	DSD90W Vertical Divider	~	RM 13.00

DS302 SERIES E SIDE ELEMENT HORIZONTAL DIVIDER SET



Soft Closing
30KG Heavy Duty



DS/30kg-450MM
DS/30kg-500MM
DS/45kg-500MM

DS-BC/142WH

DSF-XM

DSR450W
DSR500W

DS-TS/450HF
DS-TS/500HF

DSC350-478
DSC350-778
DSC350-1078

DSD90W

DS350-450mm
DS350-500mm

Technology pivot:
Bottom and Back Panel Measurement
16MM Density Panel

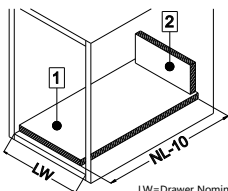

LW=Drawer Nominal Width
NL=Nominal length

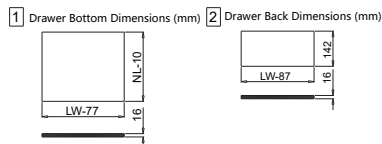

DS302-450x600 Series E

Model	1015 312 145
Cabinet Width	600 mm
Loading Capacity	30 KGS
List Price	RM 254.00

DS302-500x600 Series E

Model	1015 312 150 / 1115 312 150
Cabinet Width	600 mm
Loading Capacity	30 KGS / 45 KGS
List Price	RM 257.00 / RM 267.00

DS302-450x900 Series E

Model	1015 312 245
Cabinet Width	900 mm
Loading Capacity	30 KGS
List Price	RM 266.00

DS302-500x900 Series E

Model	1015 312 250 / 1115 312 250
Cabinet Width	900 mm
Loading Capacity	30 KGS / 45 KGS
List Price	RM 269.00 / RM 279.00

DS302-450x1200 Series E

Model	1015 312 345
Cabinet Width	1200 mm
Loading Capacity	30 KGS
List Price	RM 290.00

DS302-500x1200 Series E

Model	1015 312 350 / 1115 312 350
Cabinet Width	1200 mm
Loading Capacity	30 KGS / 45 KGS
List Price	RM 293.00 / RM 303.00

Model	Description	Length	List Price
1015 300 451	DS/30kg Drawer Runner Only 450mm	450 mm	RM 50.00
1015 300 501	DS/30kg Drawer Runner Only 500mm	500 mm	RM 50.00
1115 300 501	DS/45kg Drawer Runner Only 500mm	450 mm	RM 65.00
1015 301 501	DSF-XM Drawer Front Bracket	~	RM 10.00
1015 302 003	DS-BC/142WH Rear Connector Left/Right 142mm White	~	RM 15.00
1015 007 051	DSR450W Round Shape Railing for DS302-450mm	450 mm	RM 18.00
1015 007 052	DSR500W Round Shape Railing for DS302-500mm	500 mm	RM 18.00
DS-TS/450HF	DS-TS/450HF Drawer Body And Cover Cup (White)	450 mm	RM 50.00
DS-TS/500HF	DS-TS/500HF Drawer Body And Cover Cup (White)	500 mm	RM 50.00
1015 001 060	DSC350-478 Horizontal Divider 600mm	600 mm	RM 24.00
1015 001 090	DSC350-778 Horizontal Divider 900mm	900 mm	RM 30.00
1015 001 120	DSC350-1078 Horizontal Divider 1200mm	1200 mm	RM 42.00
1015 002 001	DSD90W Vertical Divider	~	RM 13.00
1015 302 001	DS350-450mm Acrylic Heightening Plate 450mm	450 mm	RM 39.00
1015 302 002	DS350-500mm Acrylic Heightening Plate 500mm	500 mm	RM 42.00

DS304 SERIES E SIDE ELEMENT HORIZONTAL DIVIDER SET



Soft Closing
30KG Heavy Duty



DS/30kg-450MM
DS/30kg-500MM
DS/45kg-500MM

DS-BC/142WH

DSF-XM

DSR450B-W
DSR500B-W

DS-TS/450HF
DS-TS/500HF

DSC350-478
DSC350-778
DSC350-1078

DSD90W

DS350-450mm
DS350-500mm

Technology pivot:
Bottom and Back Panel Measurement
16MM Density Panel

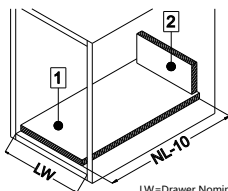

LW=Drawer Nominal Width
NL=Nominal length

1 Drawer Bottom Dimensions (mm) 2 Drawer Back Dimensions (mm)

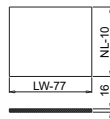

DS304-450x600 Series E

Model	1015 312 145
Cabinet Width	600 mm
Loading Capacity	30 KGS
List Price	RM 254.00

DS304-500x600 Series E

Model	1015 312 150 / 1115 312 150
Cabinet Width	600 mm
Loading Capacity	30 KGS / 45 KGS
List Price	RM 257.00 / RM 267.00

DS304-450x900 Series E

Model	1015 312 245
Cabinet Width	900 mm
Loading Capacity	30 KGS
List Price	RM 266.00

DS304-500x900 Series E

Model	1015 312 250 / 1115 312 250
Cabinet Width	900 mm
Loading Capacity	30 KGS / 45 KGS
List Price	RM 269.00 / RM 279.00

DS304-450x1200 Series E

Model	1015 312 345
Cabinet Width	1200 mm
Loading Capacity	30 KGS
List Price	RM 290.00

DS304-500x1200 Series E

Model	1015 312 350 / 1115 312 350
Cabinet Width	1200 mm
Loading Capacity	30 KGS / 45 KGS
List Price	RM 293.00 / RM 303.00

Model	Description	Length	List Price
1015 300 451	DS/30kg Drawer Runner Only 450mm	450 mm	RM 50.00
1015 300 501	DS/30kg Drawer Runner Only 500mm	500 mm	RM 50.00
1115 300 501	DS/45kg Drawer Runner Only 500mm	450 mm	RM 65.00
1015 301 501	DSF-M Drawer Front Bracket	~	RM 10.00
1015 304 004	DS-BC/185WH Rear Connector Left/Right 185mm White	~	RM 22.00
1015 007 054	DSR450B-W Round Shape Railing for DS304-450mm	450 mm	RM 18.00
1015 007 053	DSR500B-W Round Shape Railing for DS304-500mm	500 mm	RM 18.00
DS-TS/450HF	DS-TS/450HF Drawer Body And Cover Cup (White)	450 mm	RM 50.00
DS-TS/500HF	DS-TS/500HF Drawer Body And Cover Cup (White)	500 mm	RM 50.00
1015 001 060	DSC350-478 Horizontal Divider 600mm	600 mm	RM 24.00
1015 001 090	DSC350-778 Horizontal Divider 900mm	900 mm	RM 30.00
1015 001 120	DSC350-1078 Horizontal Divider 1200mm	1200 mm	RM 42.00
1015 002 001	DSD90W Vertical Divider	~	RM 13.00
1015 304 001	DS351-450mm Acrylic Heightening Plate 450mm	450 mm	RM 52.00
1015 304 002	DS351-500mm Acrylic Heightening Plate 500mm	500 mm	RM 55.00

DRAWER SYSTEM INSTRUCTION

Front fixing brackets mounting

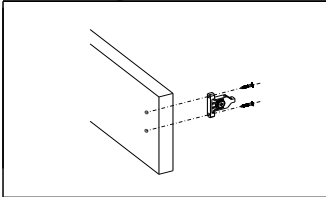

Front panel height adjustment $\pm 2\text{mm}$

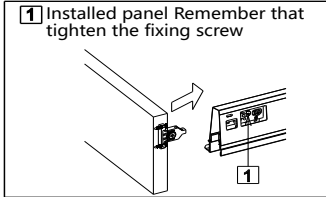

1 Installed panel Remember that tighten the fixing screw
Front panel side adjustment right 1mm

Front panel removing

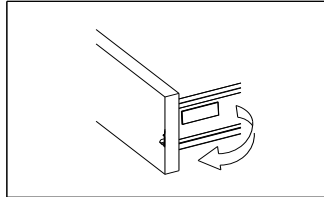

Front panel side adjustment left 1mm

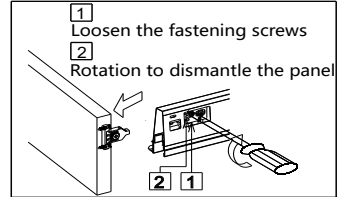

1 Loosen the fastening screws
2 Rotation to dismantle the panel

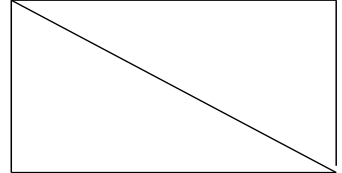
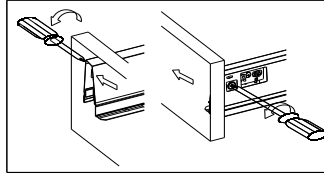
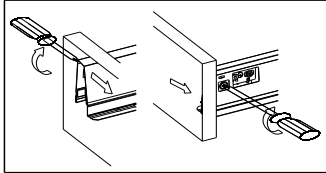
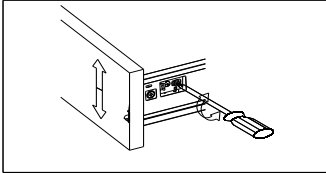

Mounting the drawer

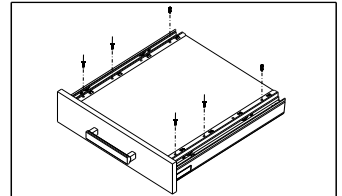
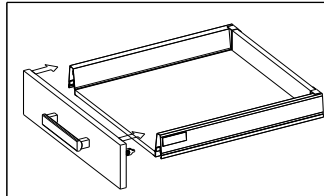
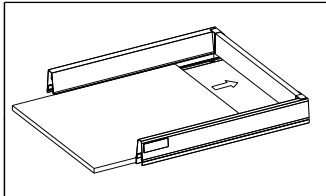
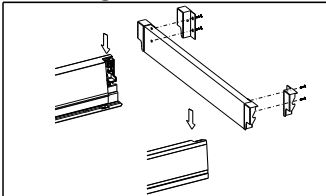

Installing the drawer

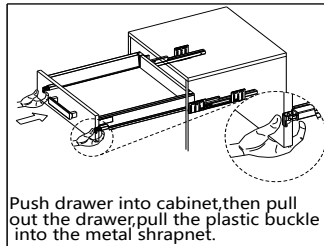
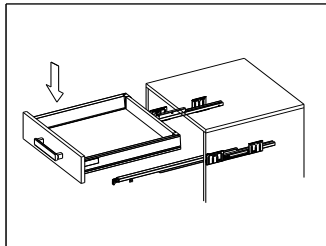
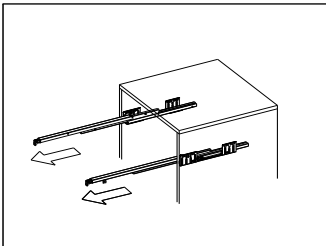

Removing the drawer

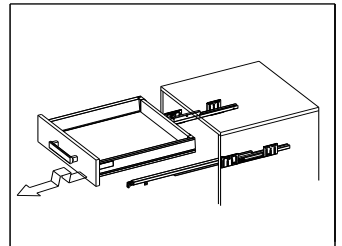

Push drawer into cabinet, then pull out the drawer, pull the plastic buckle into the metal shrapnet.

Function of the damper

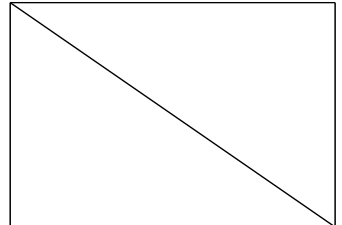
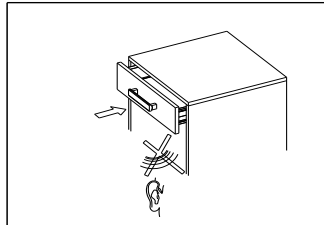
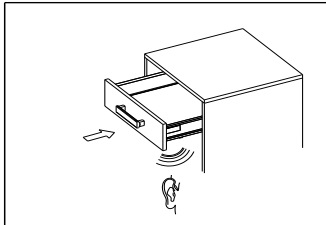
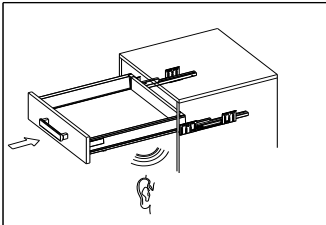

DS302 and DS 304 Mounting the drawer

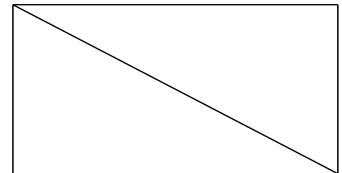
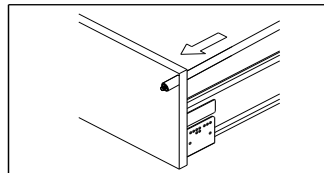
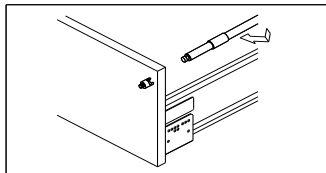
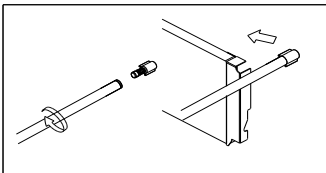

Square Railing Mounting the drawer

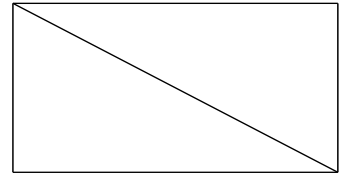
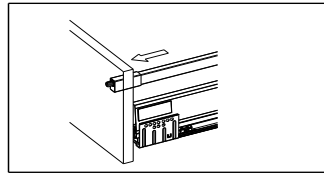
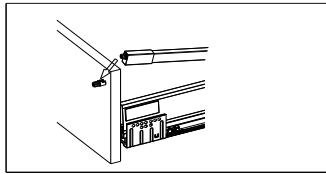
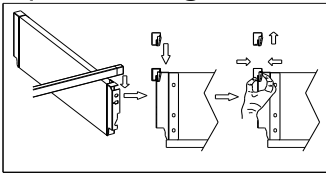

Glass installation

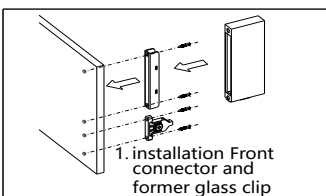

1. installation Front connector and former glass clip

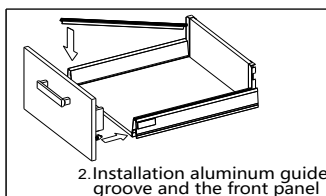

2. Installation aluminum guide groove and the front panel

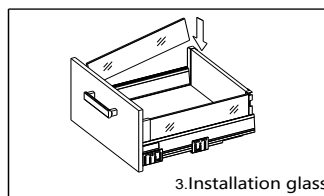

3. Installation glass

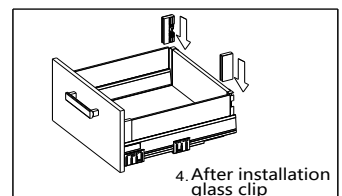

4. After installation glass clip



BENNO SERIES UNDEMOUNT RUNNER

DS 31E1 SILENT UNDER MOUNT RUNNER



Runner

Front Bracket

DS31E1-300

Model	1016 301 300
Lenght	300 mm
Loading Capacity	30 KGS
List Price	RM 48.00

DS31E1-350

Model	1016 301 350
Lenght	350 mm
Loading Capacity	30 KGS
List Price	RM 48.00

DS31E1-400

Model	1016 301 400
Lenght	400 mm
Loading Capacity	30 KGS
List Price	RM50.00

DS31E1-450

Model	1016 301 450
Lenght	450 mm
Loading Capacity	30 KGS
List Price	RM 52.00

DS31E1-500

Model	1016 301 500
Lenght	500 mm
Loading Capacity	30 KGS
List Price	RM 54.00

DS31E1-550

Model	1016 301 550
Lenght	550 mm
Loading Capacity	30 KGS
List Price	RM 56.00

InstallationDimensions(mm)

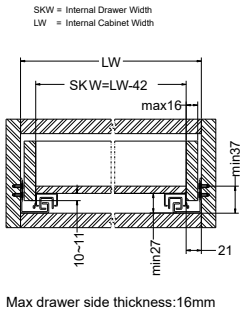

Hole position(mm)

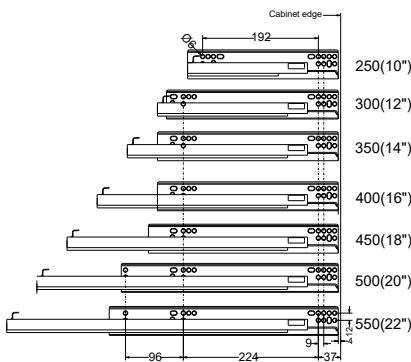

Drawer Size And Holing

Button 1: Push and pull without tools adjustment highly0→3
 Button 2: Rotate the handle without tools adjustment to easily remove the drawer!

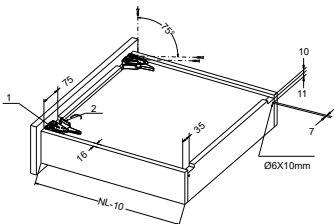

Installation Dimensions

LT = Internal Cabinet Depth
 NL = Nominal Slide Length

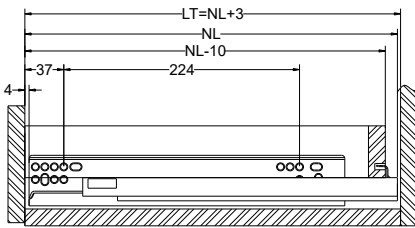

Standard drawer
 LT min=NL+3

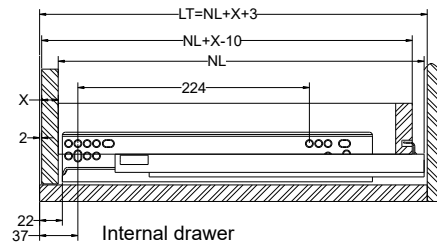

Internal drawer
 LT min=NL+X+3

Model	Description	Lenght	List Price
1016 301 000	DS31E1 Undermount Runner Front Bracket	~	RM 10.00

DS 33F7 SILENT UNDER MOUNT RUNNER



DS33F7-400N	
Model	1018 403 400
Lenght	400 mm
Loading Capacity	30 KGS
List Price	RM 56.00
DS33F7-450N	
Model	1018 403 450
Lenght	450 mm
Loading Capacity	30 KGS
List Price	RM 58.00
DS33E7-500N	
Model	1018 403 500 / 1118 303 500
Lenght	500 mm
Loading Capacity	30 KGS / 45 KGS
List Price	RM 60.00 / RM 73.00



Runner



Front Bracket

Installation Dimensions (mm) ons (mm)

SKW = Internal Drawer Width
LW = Internal Cabinet Width

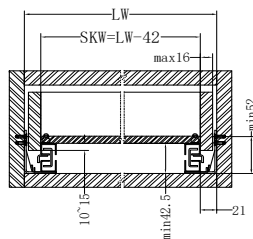

Hole position (mm)

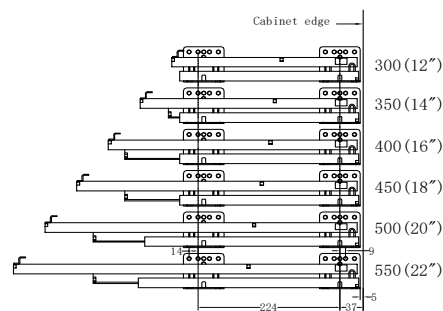

Installation Dimensions (mm)

NL = Nominal Slide Length LT = Internal Cabinet Depth

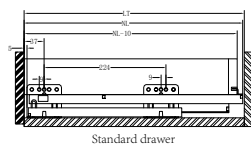

Standard drawer

Standard drawer LT min = NL + 3
Internal drawer LT min = NL + X + 3

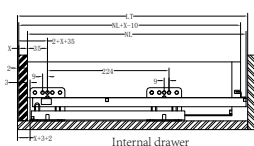

Internal drawer

Drawer size and boring (mm)

Button 1: Push and pull without tools adjustment highly 0 - +3
Button 2: Rotate the handle without tools adjustment to easily remove the drawer!

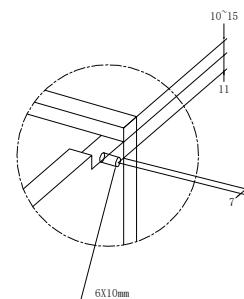
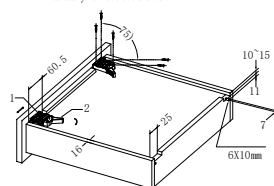

Model	Description	Lenght	List Price
1018 303 001	DS33F7 Undermount Runner Front Bracket	~	RM 10.00

DS 31E7 PUSH OPEN UNDER MOUNT RUNNER



Runner



Front Bracket

Installation Dimensions (mm)

SKW = Internal Drawer Width
LW = Internal Cabinet Width

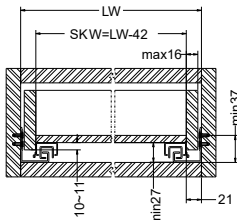

Max drawer side thickness: 16mm

Hole position (mm)

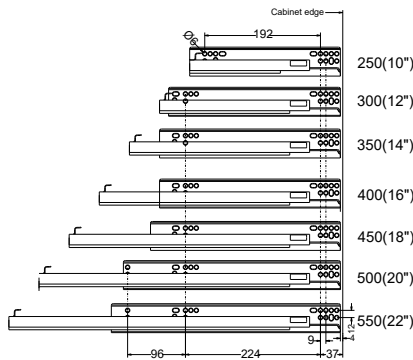

DS31E7-300

Model	DS31E7-300
Length	300 mm
Loading Capacity	30 KGS
List Price	RM 47.00

DS31E7-350

Model	DS31E7-350
Length	350 mm
Loading Capacity	30 KGS
List Price	RM 47.00

DS31E7-400

Model	DS31E7-400
Length	400 mm
Loading Capacity	30 KGS
List Price	RM 49.00

DS31E7-450

Model	DS31E7-450
Length	450 mm
Loading Capacity	30 KGS
List Price	RM 51.00

DS31E7-500

Model	DS31E7-500
Length	500 mm
Loading Capacity	30 KGS
List Price	RM 55.00

Drawer Size And Hoing

Button 1: Push and pull without tools adjustment high 0-3
Button 2: Rotate the handle without tools adjustment to easily remove the drawer!

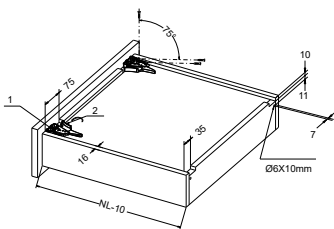

Installation Dimensions

LT = Internal Cabinet Depth
NL = Nominal Slide Length

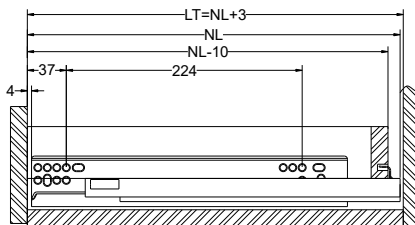

Standard drawer
LT min=NL+3

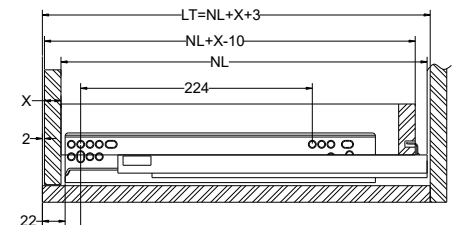

Internal drawer
LT min=NL+X+3

Model	Description	Length	List Price
1016 301 000	DS31E1 Undermount Runner Front Bracket	~	RM 10.00

DS 35H1 SYCHONIZED UNDER MOUNT RUNNER



Runner



Front Bracket

DS35H1-400mm

Model	1016 311 400
Lenght	400 mm
Loading Capacity	30 KGS
List Price	RM 68.00

DS35H1-450mm

Model	1016 311 450
Lenght	450 mm
Loading Capacity	30 KGS
List Price	RM 70.00

DS35H1-500mm

Model	1016 311 500
Lenght	500 mm
Loading Capacity	30 KGS
List Price	RM 75.00

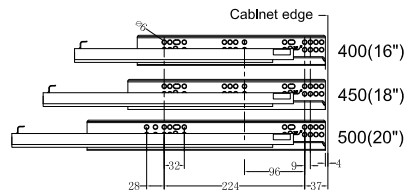
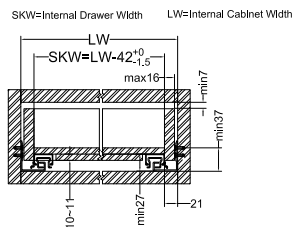

Drawer size and boring(mm)

- Button 1: Rotate without tools side adjustment ± 2.0
- Button 2: Push and pull without tools adjustment highly $+3.0$
- Button 3: Rotate the handle without tools adjustment to easily remove the drawer!

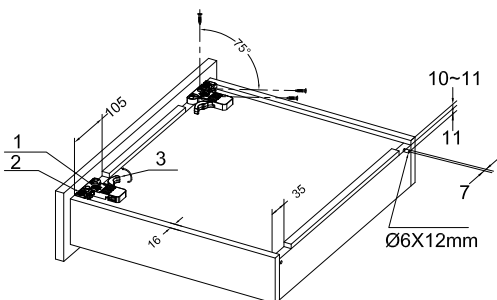

Installation Dimensions(mm)

NL=Nominal Slide Length
LT=Internal Cabinet Depth

Standard drawer $LT_{min}=NL+3$

Internal drawer $LT_{min}=NL+X+3$

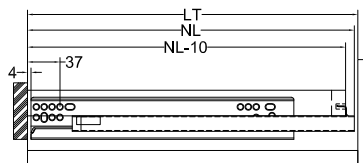

Standard drawer

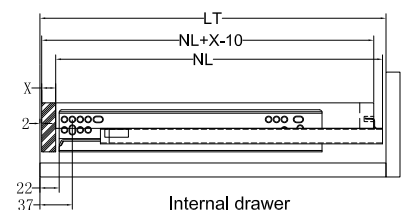

Internal drawer

Model	Description	Lenght	List Price
1015 300 451	DS35E1 Undermount Runner Front Bracket	300 mm	RM 10.00

TN45N F/Ext Soft Close B/Bearing Slide Black



TN45-300

Model	TN45-300
Lenght	300 mm
Loading Capacity	25 KGS
List Price	RM 26.50

TN45-350

Model	TN45-350
Lenght	350 mm
Loading Capacity	25 KGS
List Price	RM 29.00

TN45-400

Model	TN45-400
Lenght	400 mm
Loading Capacity	25 KGS
List Price	RM 32.00

TN45-450

Model	TN45-450
Lenght	450 mm
Loading Capacity	25 KGS
List Price	RM 34.50

TN45-500

Model	TN45-500
Lenght	500 mm
Loading Capacity	25 KGS
List Price	RM 37.00

TN45-550

Model	TN45-550
Lenght	550 mm
Loading Capacity	25 KGS
List Price	RM 39.50

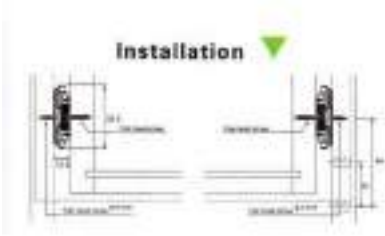

Product Parameter

Item No.	Length	Travel
10"	250	200
12"	300	260
14"	350	320
16"	400	380
18"	450	430
20"	500	480
22"	550	530
24"	600	580

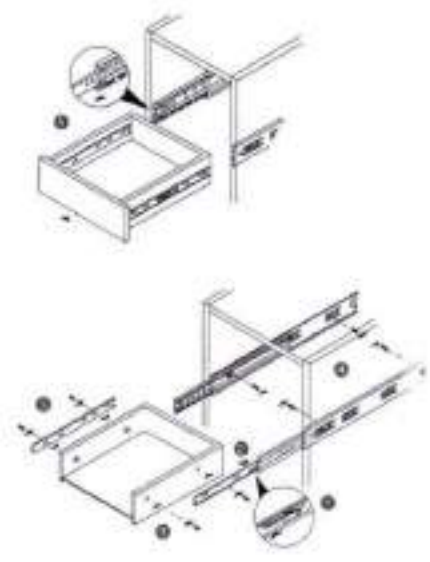



DRAWER ORGANIZER SERIES

DS210C STAINLESS STEEL DRAWER ORGANIZER

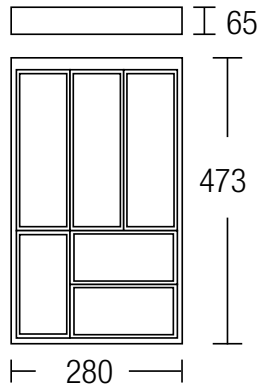

DS210C S/S DRAWER ORGANIZER

Model	1014 022 001
Depth	473 mm
Width	280 mm
Height	65 mm
List Price	RM 190.00

DS210I STAINLESS STEEL DRAWER ORGANIZER

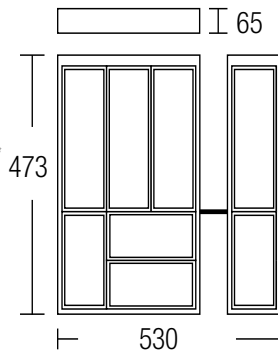

DS210I S/S DRAWER ORGANIZER

Model	1014 022 002
Depth	473 mm
Width	530 mm
Height	65 mm
List Price	RM 290.00

DS210CC STAINLESS STEEL DRAWER ORGANIZER

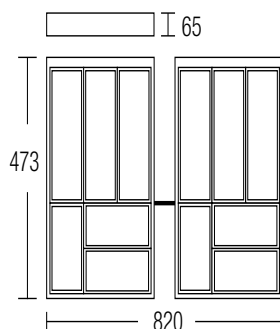

DS210CC S/S DRAWER ORGANIZER

Model	1014 022 003
Depth	473 mm
Width	820 mm
Height	65 mm
List Price	RM 390.00

CUTLERY TRAY M/GREY



50mm

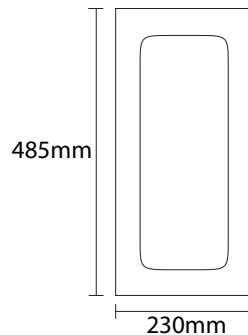
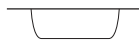

C300mm Cutlery Tray M/Grey

Model	1014 003 030
Depth	415 - 483 mm
Width	170 - 230 mm
Height	50 mm
List Price	RM 30.00



50mm

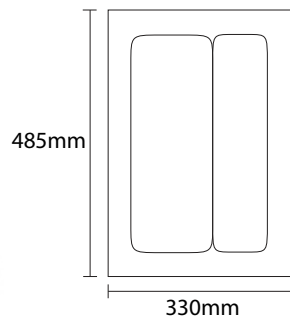

C400mm Cutlery Tray M/Grey

Model	1014 003 040
Depth	415 - 483 mm
Width	270 - 230 mm
Height	50 mm
List Price	RM 35.00



50mm

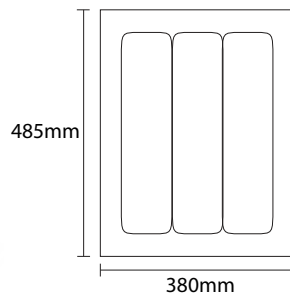

C450mm Cutlery Tray M/Grey

Model	1014 003 045
Depth	415 - 483 mm
Width	320 - 230 mm
Height	50 mm
List Price	RM 45.00



50mm

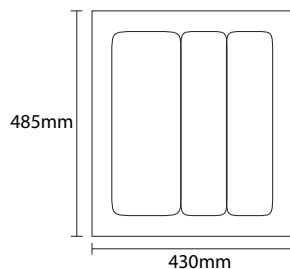

C500mm Cutlery Tray M/Grey

Model	1014 003 050
Depth	415 - 483 mm
Width	320 - 230 mm
Height	50 mm
List Price	RM 49.00

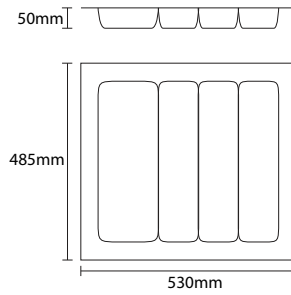

C600mm Cutlery Tray M/Grey

Model	1014 003 060
Depth	415 - 483 mm
Width	470 - 230 mm
Height	50 mm
List Price	RM 60.00

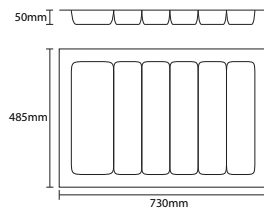

C800mm Cutlery Tray M/Grey

Model	1014 003 080
Depth	415 - 483 mm
Width	670 - 230 mm
Height	50 mm
List Price	RM 77.00

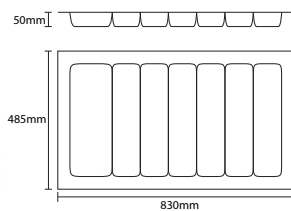

C900mm Cutlery Tray M/Grey

Model	1014 003 090
Depth	415 - 483 mm
Width	770 - 230 mm
Height	50 mm
List Price	RM 81.00

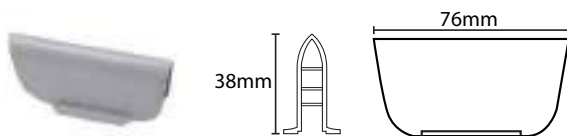

C901 Divider Cutlery Tray

Model	1014 003 501
Width	76 mm
Height	38 mm
List Price	RM 2.00/NETT

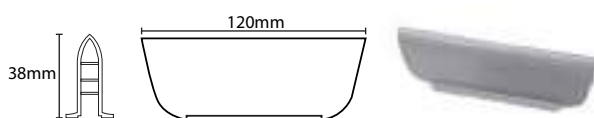

C902 Divider Cutlery Tray

Model	1014 003 502
Width	120 mm
Height	38 mm
List Price	RM 2.00/NETT



PREMIUM SERIES STORAGE SYSTEM

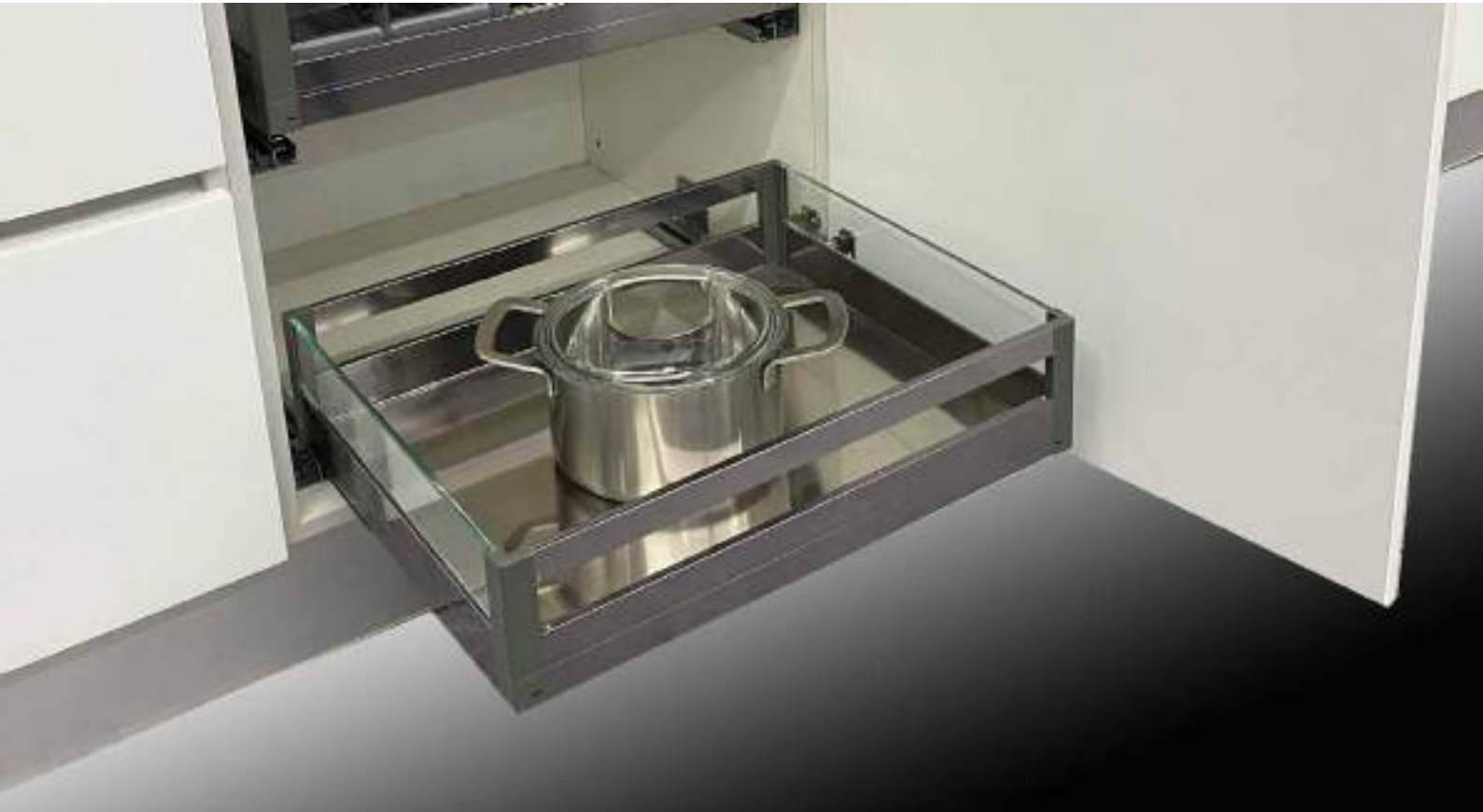

ALUMINIUM FOUR SIDE PULLOUT BASKET



HBP28960M

Model	HBP28960M
Width	564 mm
Depth	425 mm
Height	168 mm
Carcase	600 mm
List Price	RM 370.00

HBP28990M

Model	HBP28990M
Width	864 mm
Depth	425 mm
Height	168 mm
Carcase	900 mm
List Price	RM 425.00

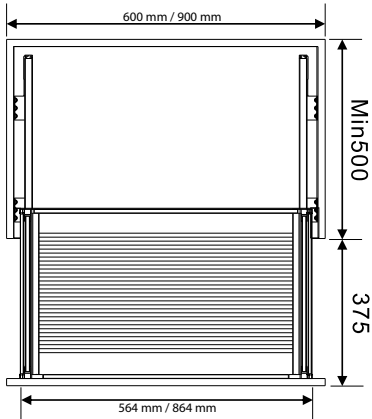
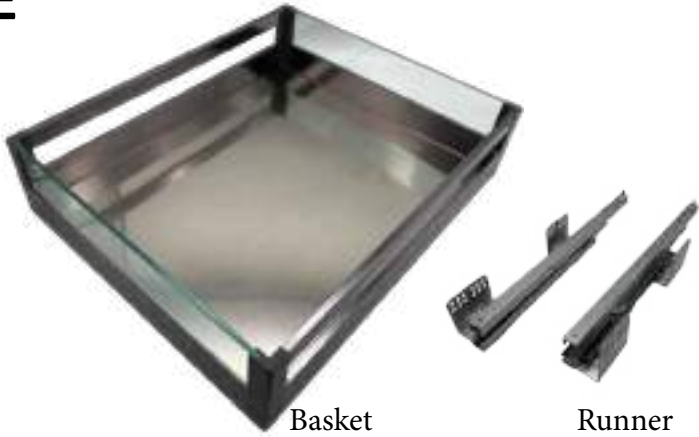

PREMIUM SERIES

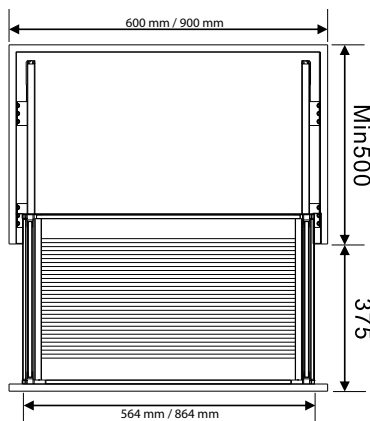

ALUMINIUM FOUR SIDE MULTIFUNCTION PULL OUT BASKET



HBP27860M

Model	HBP27860M
Width	564 mm
Depth	425 mm
Height	168 mm
Carcase	600 mm
List Price	RM 505.00

HBP27890M

Model	HBP27890M
Width	864 mm
Depth	425 mm
Height	168 mm
Carcase	900 mm
List Price	RM 605.00



ALUMINIUM THREE SIDE PULL OUT BASKET



HBP218960M	
Model	HBP218960M
Width	564 mm
Depth	425 mm
Height	168 mm
Carcase	600 mm
List Price	RM 350.00
HBP218990M	
Model	HBP218990M
Width	864 mm
Depth	425 mm
Height	168 mm
Carcase	900 mm
List Price	RM 400.00

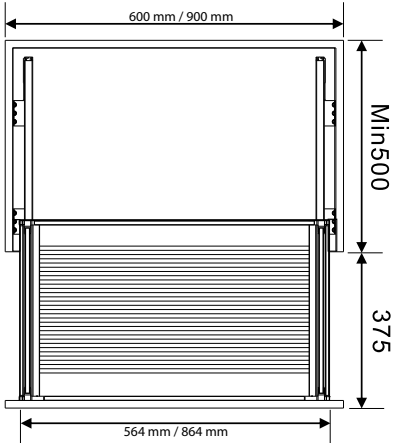

PREMIUM SERIES

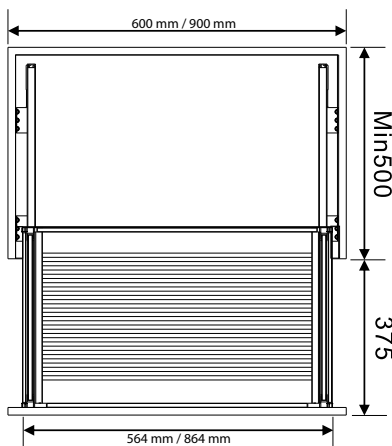

ALUMINIUM THREE SIDE MULTIFUNCTION PULL OUT BASKET



HBP217860M

Model	HBP217860M
Width	564 mm
Depth	425 mm
Height	168 mm
Carcase	600 mm
List Price	RM 480.00

HBP217890M

Model	HBP217890M
Width	864 mm
Depth	425 mm
Height	168 mm
Carcase	900 mm
List Price	RM 575.00



ALUMINIUM GLASS MAGIC CORNER



Door Basket



Inner Basket

HBP2020L

Model	HBP2020L
Width	864 mm
Depth	480 mm
Height	525 mm
Carcase	900 mm
List Price	RM 1038.00

HBP2020R

Model	HBP2020R
Width	864 mm
Depth	480 mm
Height	525 mm
Carcase	900 mm
List Price	RM 1038.00

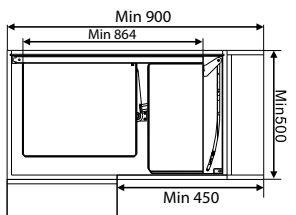
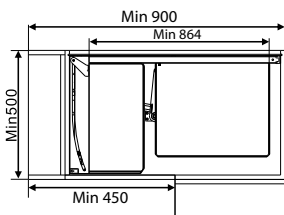
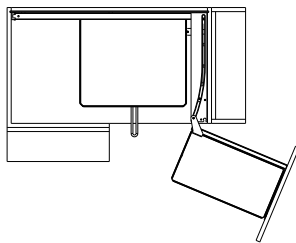
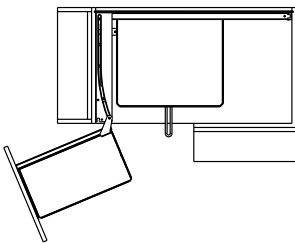

PREMIUM SERIES



ALUMINIUM GLASS BASE UNIT DELUXE LARDER



Inner Basket



Door Basket



HBP48445

Model	HBP48445
Width	410 mm
Depth	450 mm
Height	532 mm
Carcase	450 mm
List Price	RM 520.00

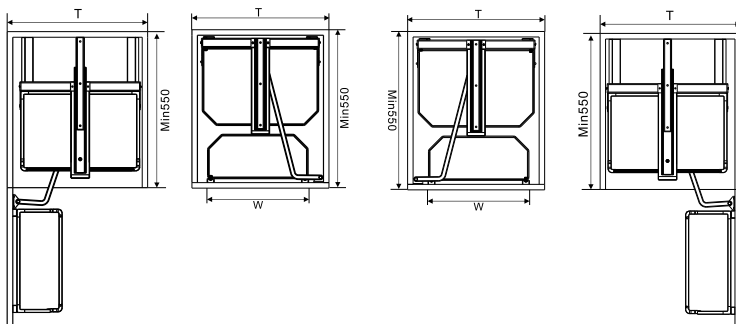



ALUMINIUM UTILITY 3 LAYER PULL OUT BASKET



HBP47540

Model	HBP47540
Width	350 mm
Depth	425 mm
Height	480 mm
Carcase	400 mm
List Price	RM 700.00

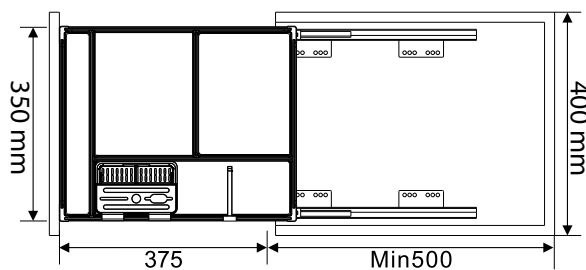

Basket



Runner

PREMIUM SERIES



MAGIC COLECTOR ALUMINIUM GLASS MENTAL DEFICIENCY FUNCTIONS

B407

Model	B407
Width	867 mm
Depth	265 mm
Height	540 mm
Carcase	900 mm
List Price	RM 1200.00

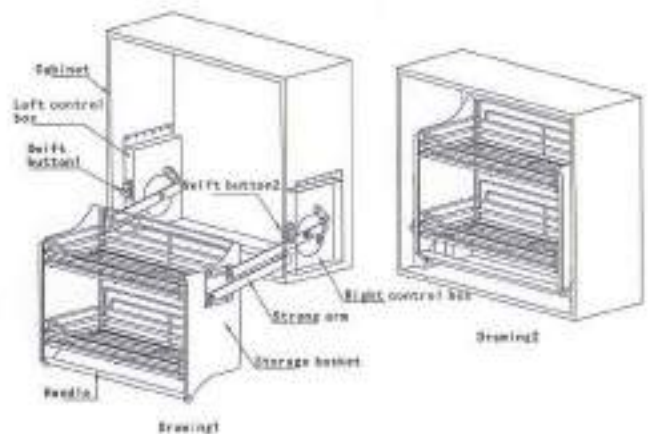

ALUMINIUM GLASS TALL LARDER



Aluminium And Glass Larder 4 Basket

Model	HBP43440A
Width	345 mm
Depth	460 mm
Height	1150 - 1450 mm
Carcase	400 mm
List Price	RM 1250.00

Aluminium And Glass Larder 6 Basket

Model	HBP43640AH
Width	345 mm
Depth	460 mm
Height	1850 - 2150 mm
Carcase	400 mm
List Price	RM 1550.00

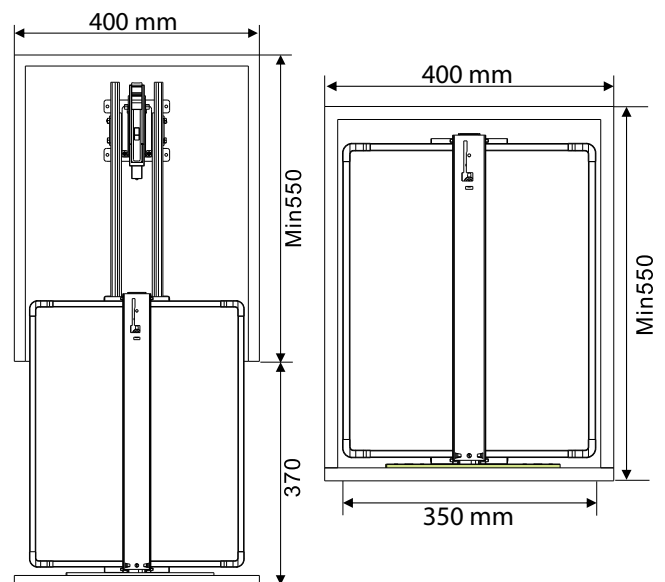

PREMIUM SERIES

ALUMINIUM GLASS DELUXE LARDER

Aluminium And Glass Deluxe Larder 12 Basket (450 mm)

Model	HBP42645M
Width	420 mm
Depth	450 mm
Height	1850 - 2150 mm
Carcase	450 mm
List Price	RM 1700.00

Aluminium And Glass Deluxe Larder 12 Basket (600 mm)

Model	HBP42660M
Width	520 mm
Depth	450 mm
Height	1850 - 2150 mm
Carcase	600 mm
List Price	RM 2000.00



Inner Basket



Door Basket

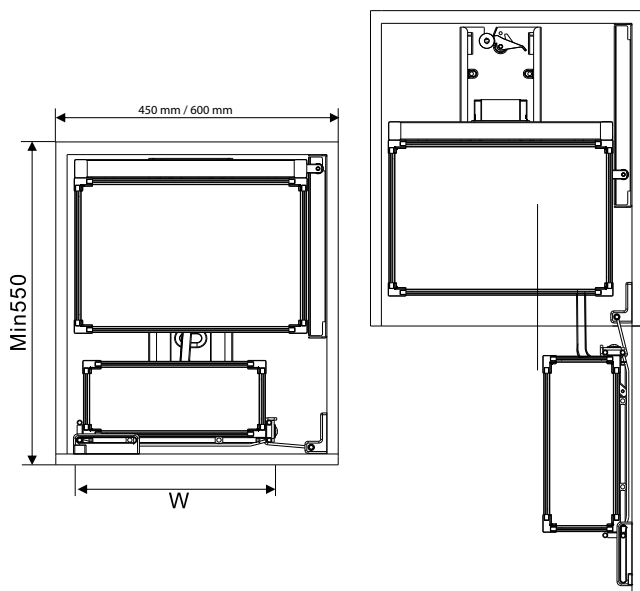

CLASSIC SERIES





STORAGE SYSTEM



SOFT CLOSE PULL OUT BASKET

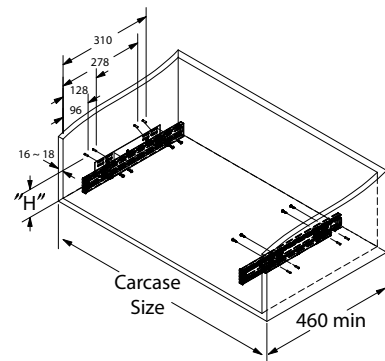
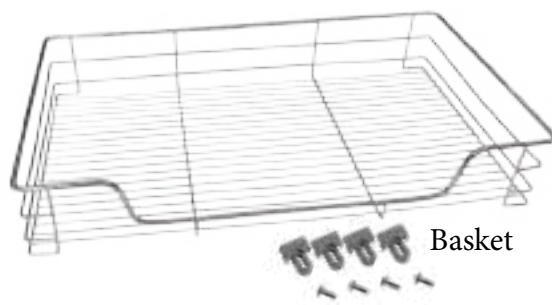

Model	Description	Carcase	Dimension (W x D x H)	Finishing	List Price
S-HBJ04040	S-HBJ04040 Chrome P.O.B c/w Undermount runner	400 mm	345mm x 428mm x 140 mm	Chrome	RM 207.00
S-HBJ04045	S-HBJ04045 Chrome P.O.B c/w Undermount runner	450 mm	404mm x 428mm x 140 mm	Chrome	RM 212.00
S-HBJ04050	S-HBJ04050 Chrome P.O.B c/w Undermount runner	500 mm	454mm x 428mm x 140 mm	Chrome	RM 216.00
S-HBJ04060	S-HBJ04060 Chrome P.O.B c/w Undermount runner	600 mm	564mm x 428mm x 140 mm	Chrome	RM 224.00
S-HBJ04080	S-HBJ04080 Chrome P.O.B c/w Undermount runner	800 mm	764mm x 428mm x 140 mm	Chrome	RM 240.00
S-HBJ04090	S-HBJ04090 Chrome P.O.B c/w Undermount runner	900 mm	864mm x 428mm x 140 mm	Chrome	RM 251.00
S-HBJ24040	S-HBJ24040 S/Steel P.O.B c/w Undermount runner	400 mm	345mm x 428mm x 140 mm	S/Steel	RM 254.00
S-HBJ24045	S-HBJ24045 S/Steel P.O.B c/w Undermount runner	450 mm	404mm x 428mm x 140 mm	S/Steel	RM 262.00
S-HBJ24050	S-HBJ24050 S/Steel P.O.B c/w Undermount runner	500 mm	454mm x 428mm x 140 mm	S/Steel	RM 269.00
S-HBJ24060	S-HBJ24060 S/Steel P.O.B c/w Undermount runner	600 mm	564mm x 428mm x 140 mm	S/Steel	RM 284.00
S-HBJ24080	S-HBJ24080 S/Steel P.O.B c/w Undermount runner	800 mm	764mm x 428mm x 140 mm	S/Steel	RM 313.00
S-HBJ24090	S-HBJ24090 S/Steel P.O.B c/w Undermount runner	900 mm	864mm x 428mm x 140 mm	S/Steel	RM 333.00

SOFT CLOSE CLASSIC SERIES



SOFT CLOSE BOWL AND PLATE PULL OUT BASKET

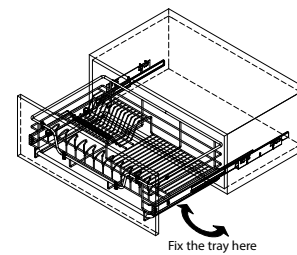
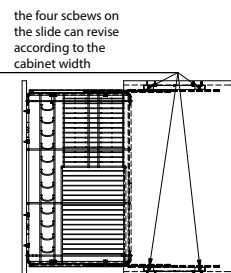
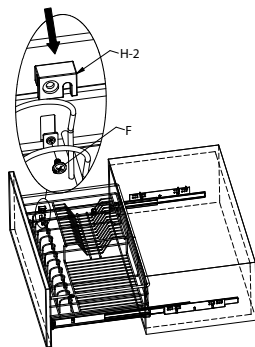
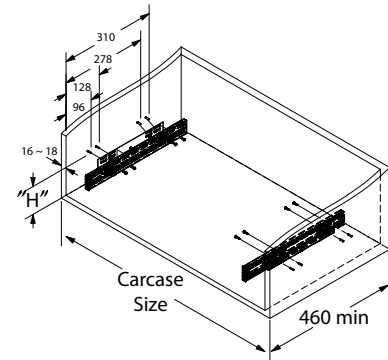
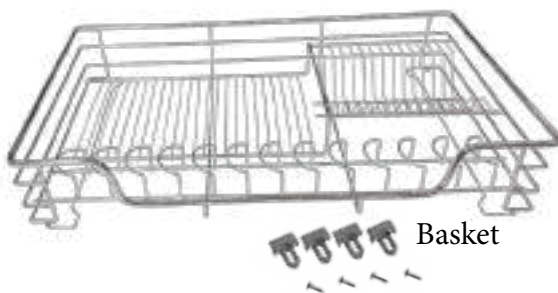

Model	Description	Carcass	Dimension (W x D x H)	Finishing	List Price
S-HBJ09090	S-HBJ09090 Chrome Bowl & Plate c/w Undermount runner	900 mm	845mm x 428mm x 140mm	Chrome	RM 308.00
S-HBJ29090	S-HBJ29090 S/Steel Bowl & Plate c/w Undermount runner	900 mm	845mm x 428mm x 140mm	S/Steel	RM 410.00



**SOFT CLOSE
CONCORD CORNER KIT**

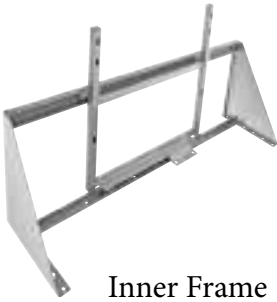

Inner Frame



Door Frame

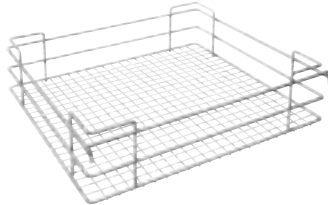

Inner Basket

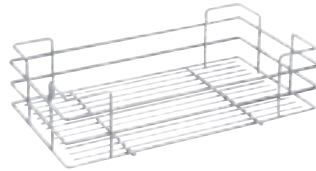

Door Basket

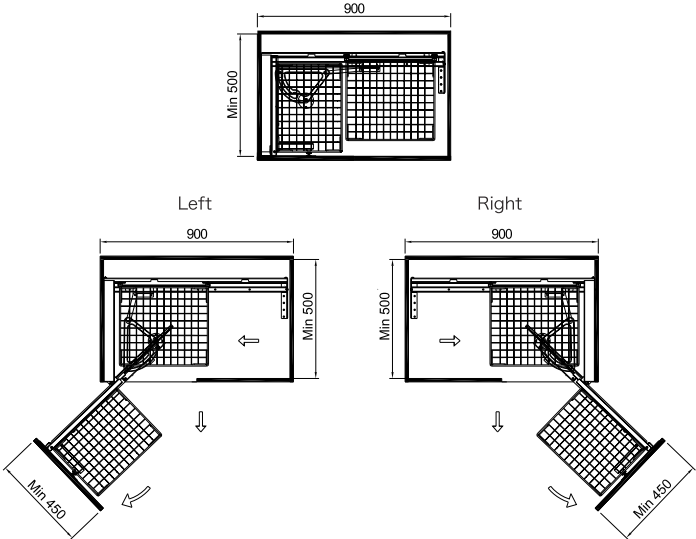

Model	Description	Carcase	Dimension (W x D x H)	Finishing	List Price
2021 040 031	B04031 Concord Corner Left	900 mm	438/260mm x 428mm x 221mm	Chrome	RM 1028.00
2021 040 032	B04032 Concord Corner Right	900 mm	438/260mm x 428mm x 221mm	Chrome	RM 1028.00

SOFT CLOSE CLASSIC SERIES



SOFT CLOSE SMALL SIDE MOUNTED KIT

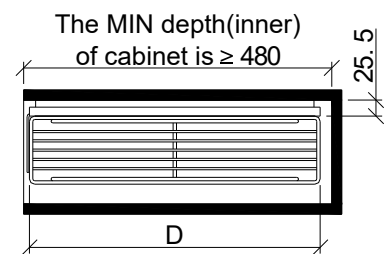
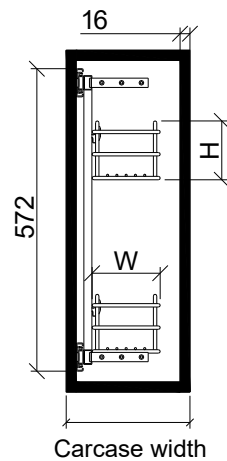
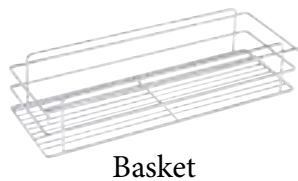

Model	Description	Carcase	Dimension (W x D x H)	Finishing	List Price
BB715A	BB715A Side Mounted Kit c/w Ball Bearing Soft Close - Anthracite	150 mm	95mm x 455mm x 95mm	Chrome	RM 234.00
BB720A	BB720A Side Mounted Kit c/w Ball Bearing Soft Close - Anthracite	200 mm	110mm x 455mm x 95mm	Chrome	RM 252.00
BB730A	BB730A Side Mounted Kit c/w Ball Bearing Soft Close - Anthracite	300 mm	210mm x 455mm x 95mm	Chrome	RM 273.00



**SOFT CLOSE
CLEANING MATERIAL BASKET**

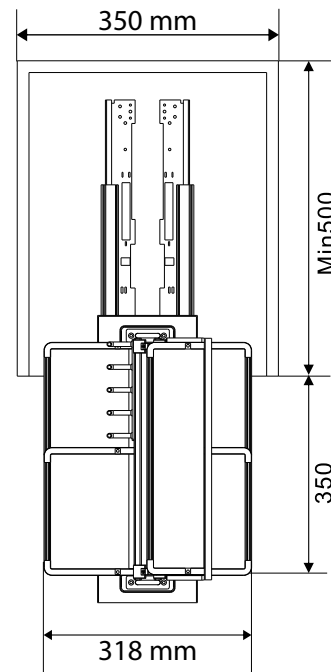

Model	Description	Carcase	Dimension (W x D x H)	Finishing	List Price
HBC52535H	HBC52535H Claening Material Pull Out Basket	350 mm	318mm x 440mm x 405mm	Chrome	RM 510.00

SOFT CLOSE CLASSIC SERIES



SOFT COLSE SWING TRAY



Basket



Cap

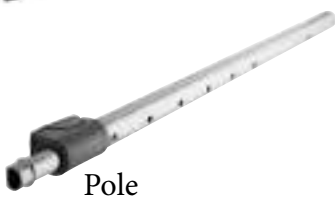

Pole



Bottom Bracket

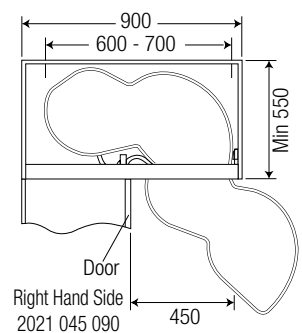
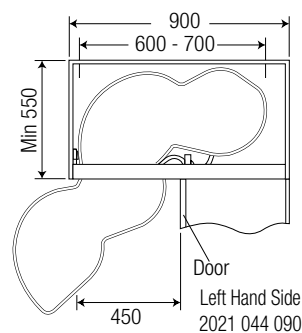

Arm



Clip



Top Bracket

Model	Description	Carcase	Dimension (W x D x H)	Finishing	List Price
2021 044 090	F101009 Swing Trays Left	900 mm	815mm x 400mm x 600 - 700mm	Chrome	RM 900.00
2021 045 090	F101010 Swing Trays Right	900 mm	815mm x 400mm x 600 - 700mm	Chrome	RM 900.00

SOFT CLOSE TALL LARDER

Wire Tall Larder 4 Basket

Model	HBC43440
Width	350 mm
Depth	460 mm
Height	1150 - 1450 mm
Carcase	400 mm
List Price	RM 940.00

Wire Tall Larder 6 Basket

Model	HBC43640H
Width	350 mm
Depth	460 mm
Height	1850 - 2150 mm
Carcase	400 mm
List Price	RM 1170.00

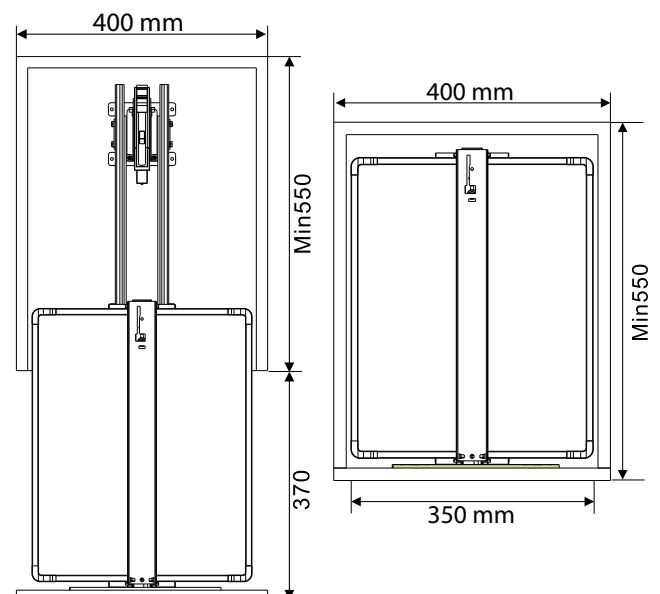

CLASSIC SERIES

WIRE DELUXE LARDER 12 BASKET

Deluxe Larder 12 Basket 450mm

Model	HBC42645H
Width	414 mm
Depth	500 mm
Height	1850 - 2150 mm
Carcase	450 mm
List Price	RM 1300.00

Deluxe Larder 12 Basket 600mm

Model	HBC42660H
Width	564 mm
Depth	500 mm
Height	1850 - 2150 mm
Carcase	600 mm
List Price	RM 1500.00

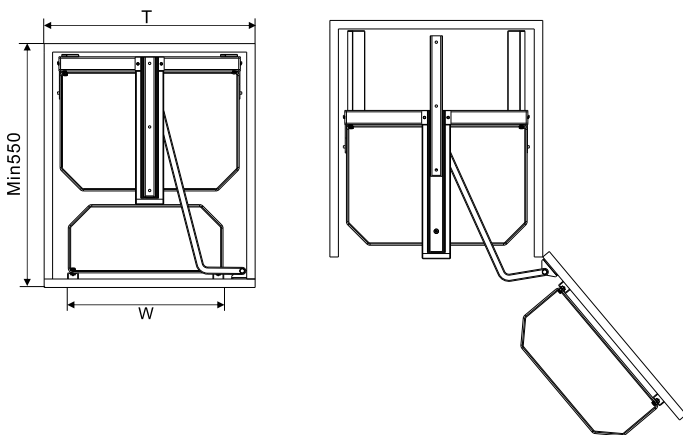
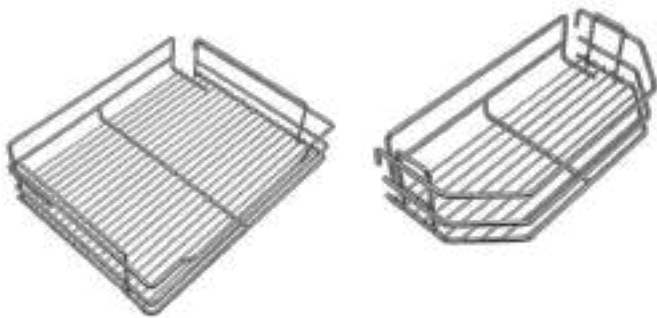



PULL OUT BASKET

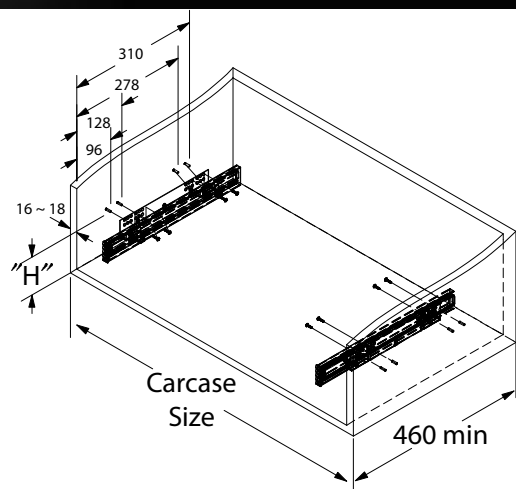

Model	Description	Carcass	Dimension (W x D x H)	Finishing	List Price
HBJ04040	HBJ04040 Chrome Pull Out Basket & Runner	400 mm	345mm x 428mm x 140 mm	Chrome	RM 114.00
HBJ04045	HBJ04045 Chrome Pull Out Basket & Runner	450 mm	404mm x 428mm x 140 mm	Chrome	RM 118.00
HBJ04050	HBJ04050 Chrome Pull Out Basket & Runner	500 mm	454mm x 428mm x 140 mm	Chrome	RM 122.00
HBJ04060	HBJ04060 Chrome Pull Out Basket & Runner	600 mm	564mm x 428mm x 140 mm	Chrome	RM 129.00
HBJ04080	HBJ04080 Chrome Pull Out Basket & Runner	800 mm	764mm x 428mm x 140 mm	Chrome	RM 146.00
HBJ04090	HBJ04090 Chrome Pull Out Basket & Runner	900 mm	864mm x 428mm x 140 mm	Chrome	RM 156.00
HBJ24040	HBJ24040 S/Steel Pull Out Basket & Runner	400 mm	345mm x 428mm x 140 mm	S/Steel	RM 160.00
HBJ24045	HBJ24045 S/Steel Pull Out Basket & Runner	450 mm	404mm x 428mm x 140 mm	S/Steel	RM 168.00
HBJ24050	HBJ24050 S/Steel Pull Out Basket & Runner	500 mm	454mm x 428mm x 140 mm	S/Steel	RM 174.00
HBJ24060	HBJ24060 S/Steel Pull Out Basket & Runner	600 mm	564mm x 428mm x 140 mm	S/Steel	RM 190.00
HBJ24080	HBJ24080 S/Steel Pull Out Basket & Runner	800 mm	764mm x 428mm x 140 mm	S/Steel	RM 219.00
HBJ24090	HBJ24090 S/Steel Pull Out Basket & Runner	900 mm	864mm x 428mm x 140 mm	S/Steel	RM 239.00

CLASSIC SERIES



BOWL AND PLATE PULL OUT BASKET

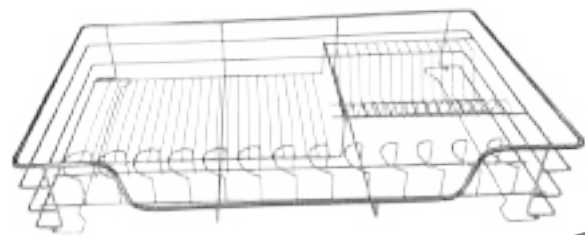
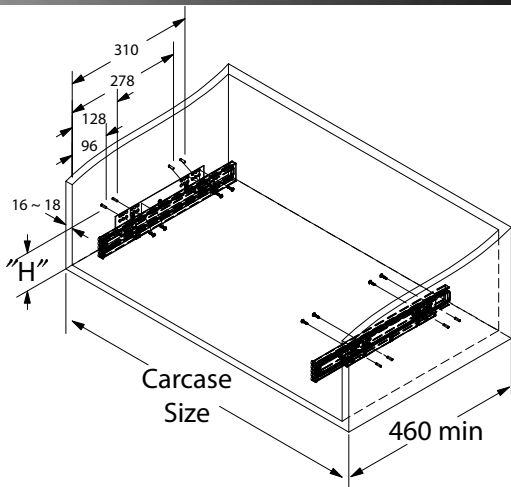

Basket



Runner

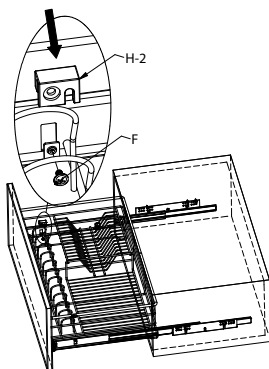

the four screws on the slide can revise according to the cabinet width

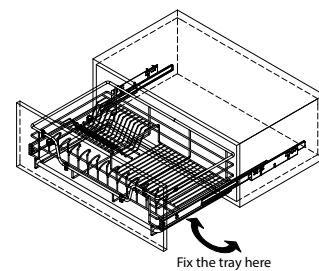
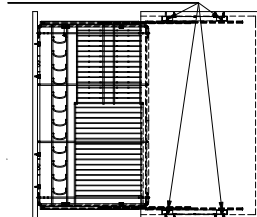

Model	Description	Carcase	Dimension (W x D x H)	Finishing	List Price
HBJ09090	HBJ09090 Bowl And Plate Basket c/w Runner	900 mm	845mm x 428mm x 140mm	Chrome	RM 214.00
HBJ29090	HBJ29090 Bowl And Plate Basket c/w Runner	900 mm	845mm x 428mm x 140mm	S/Steel	RM 316.00



UTILITY BASKET 2 LAYER

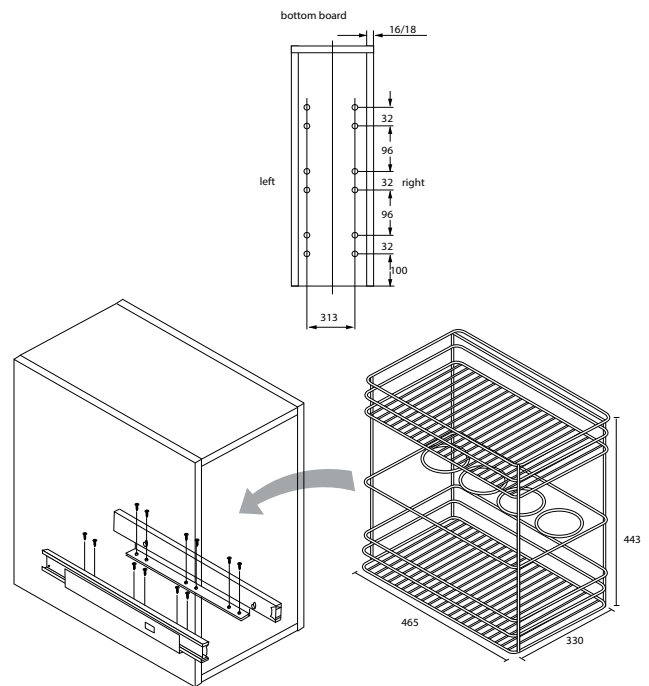

Model	Description	Carcase	Dimension (W x D x H)	Finishing	List Price
2021 008 040	A09921 Utility Basket 2 Layer 400mm	400 mm	330mm x 465mm x 443mm	Chrome	RM 291.00

CLASSIC SERIES



UTILITY BASKET 3 LAYER

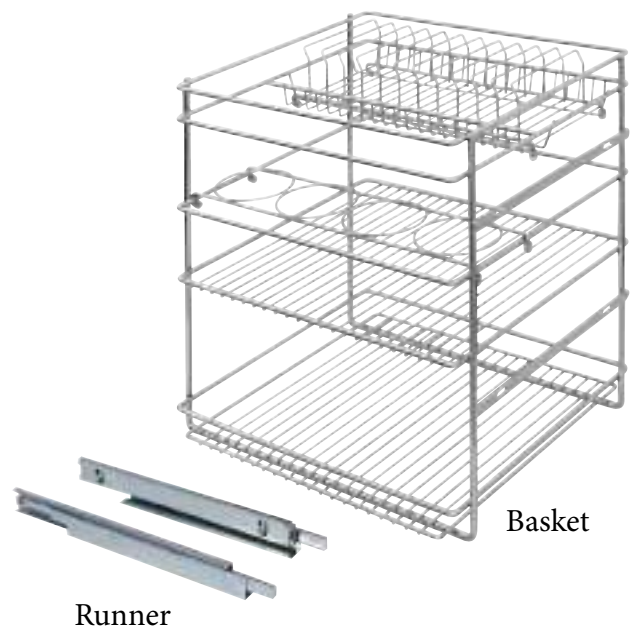
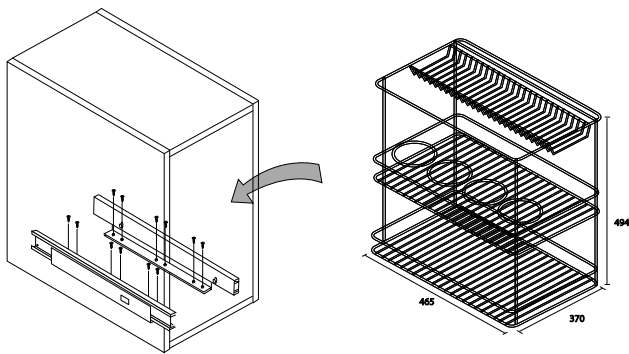
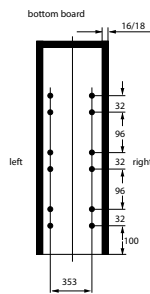

Model	Description	Carcase	Dimension (W x D x H)	Finishing	List Price
2021 008 045	A09931 Utility Basket 3 Layer 450mm	450 mm	370mm x 465mm x 494mm	Chrome	RM 373.00



CLEANING MATERIAL PULL OUT BASKET

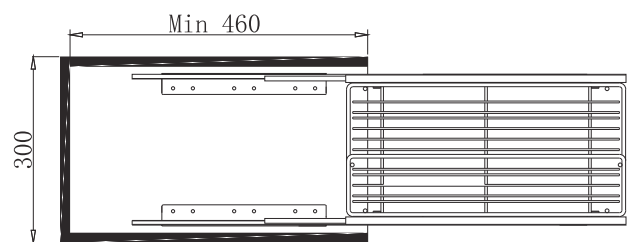
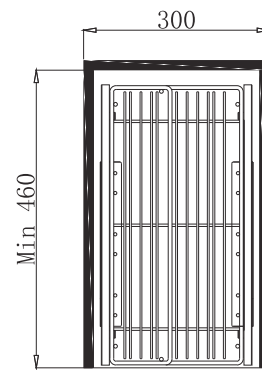
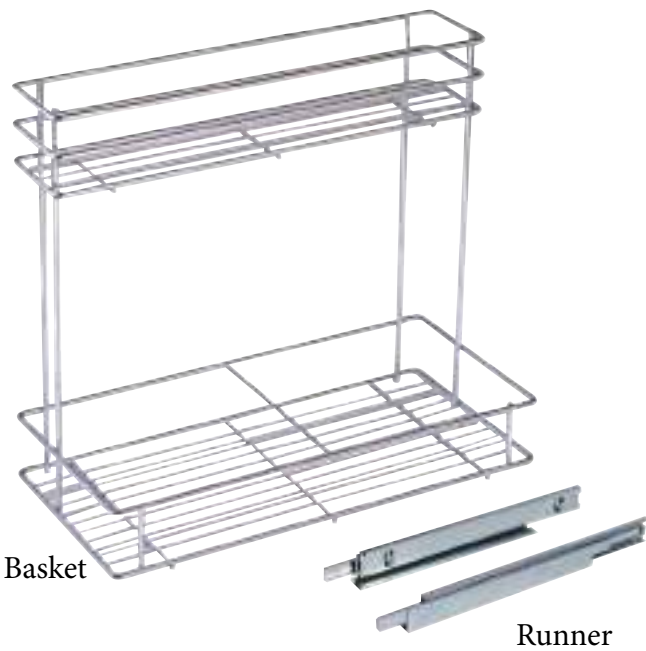

Model	Description	Carcase	Dimension (W x D x H)	Finishing	List Price
2021 006 030	A09061 Cleaning Material Basket Pull Out	350 mm	215mm x 450mm x 402mm	Chrome	RM 190.00

CLASSIC SERIES



SPACE GENIE PULL OUT

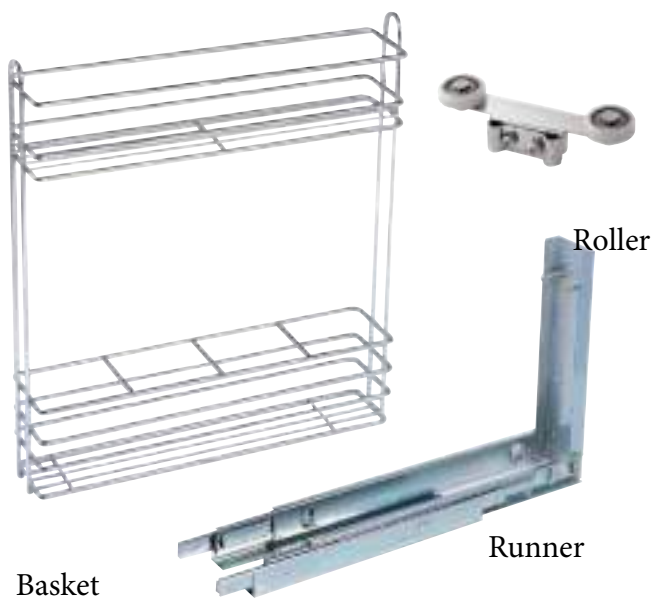
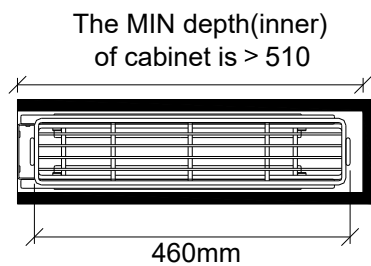
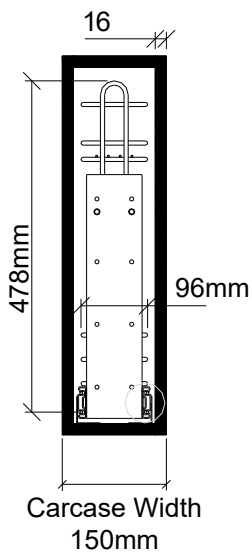

Model	Description	Carcase	Dimension (W x D x H)	Finishing	List Price
B07315A	B07315A CHrome Space Genie Pull Out - Anthracite	150 mm	96mm x 460mm x 478mm	Chrome	RM 225.00



180 ° SWIVEL BASKET KIT

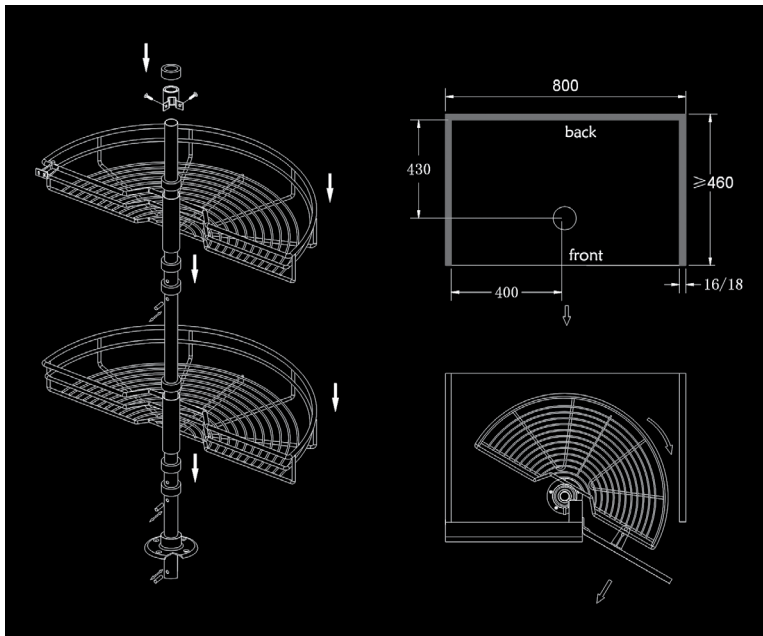

Basket



Top Bracket



Pole



Bottom Bracket



Bracket



Pin



Door Bracket

Model	Description	Carcase	Dimension (W x D x H)	Finishing	List Price
2021 018 080	B08100 'HAUSS' 180° Swivel Basket Kit	800 mm	740mm x 394mm x 115mm	Chrome	RM 295.00

CLASSIC SERIES



270 ° PIE-CUT SWIVEL BASKET KIT

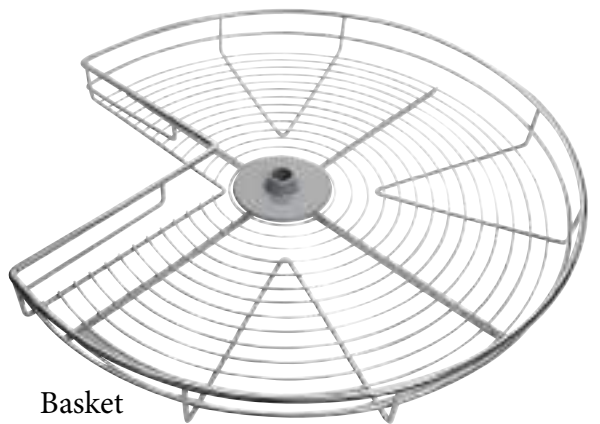

Basket



Bracket



Bracket

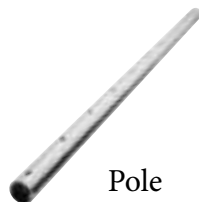

Pole



Pin



Bottom Bracket

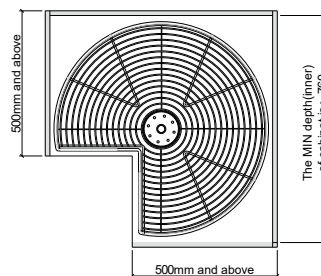
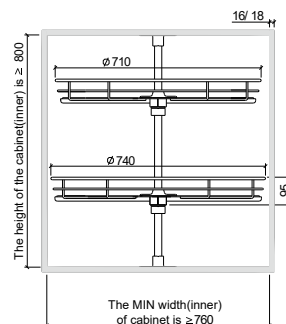

Model	Description	Carcase	Dimension (W x H)	Finishing	List Price
2021 020 080	B08200 270° 'HAUSS' Pie-Cut Swivel Basket Kit	800 mm	710mm x 90mm 740mm x 90mm	Chrome	RM 360.00



WALL UNIT INOMATIC DISH RACK

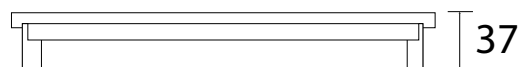
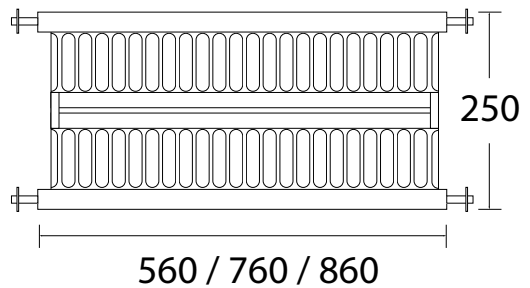
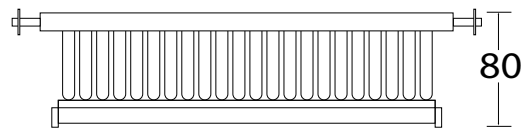

Model	Description	Carcase	Dimension (W x D x H)	Finishing	List Price
SB3604-600	SB3604-600mm Inoxmatic Dish Rack	600 mm	560mm x 250mm x 80mm	S/Steel	RM 108.00
SB3604-800	SB3604-800mm Inoxmatic Dish Rack	800 mm	760mm x 250mm x 80mm	S/Steel	RM 138.00
SB3604-900	SB3604-900mm Inoxmatic Dish Rack	900 mm	860mm x 250mm x 80mm	S/Steel	RM 153.00

CLASSIC SERIES



STAINLESS STEEL FREE STANDING DISH RACK

HB9901A

Model	HB9901A
Width	470 mm
Depth	370 mm
High	445 mm
List Price	RM 460.00



D060 STAINLESS STEEL FREE STANDING DISH RACK 600mm

D060+FA1004/5

Model	D060+FA1004/5
Width	590 mm
Depth	252 mm
High	387 mm
List Price	RM 260.00

Remark :c/w FA1004 Chopsticks Holder - 1pc , FA1005 Knife Holder - 1pc

ADDITIONAL ADD ON



FA1004 STAINLESS STEEL CHOPSTICKS HOLDER

Model	FA1004
Width	155 mm
Depth	55 mm
High	160 mm
List Price	RM 26.00



FA1005 STAINLESS STEEL KNIFE HOLDER

Model	FA1005
Width	155 mm
Depth	55 mm
High	160 mm
List Price	RM 26.00



LIGHTING SYSTEM

LIGHTING SERIES



GLASS SHELF ALUMINIUM BLACK LIGHT

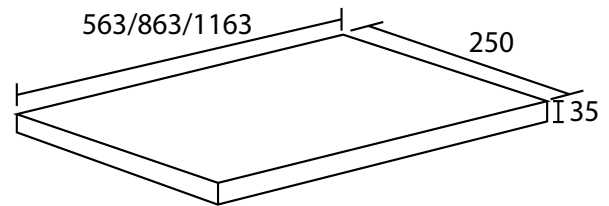

Model	Description	Carcase	Dimension (W x D x H)	Wattage	List Price
L4024-564	4024-564 LED Glass Shelf Alum. Light Black 4500k 5.2W	600 mm	563mm x 250mm x 35mm	5.2 W	RM 190.00
L4024-864	4024-864 LED Glass Shelf Alum. Light Black 4500k 8.2W	900 mm	863mm x 250mm x 35mm	8.2 W	RM 230.00
L4024-1164	4024-1164 LED Glass Shelf Alum. Light Black 4500k 10.6W	1200 mm	1163mm x 250mm x 35mm	10.6 W	RM 290.00



LED Touch Sensor Light (Under Cabinet Application)

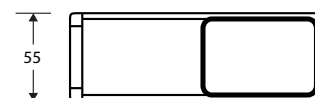
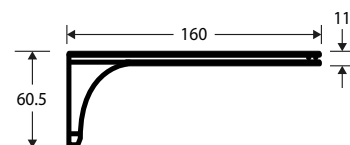

Model	Description	Carcase	Dimension (W x D x H)	Wattage	List Price
L3043105	L3043105 LED Touch Sensor Under Cabinet Light 4500k 3.5W	~	160mm x 55mm x 60.5mm	3.5W	RM 75.00



BADROOM FLEXIBEL SIDE LAMP

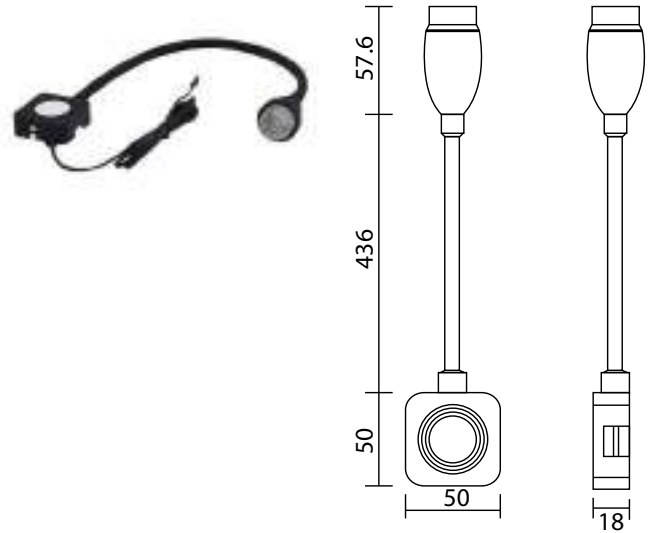

Model	Description	Carcase	Dimension (W x D x H)	Wattage	List Price
B1005006	B1005006 Bedroom Flexibel Side Lamp 4500k 2W	~	493mm x 50mm x 18mm	2.0 W	RM 140.00



LED HANGING ROD PIR SENSOR LIGHT

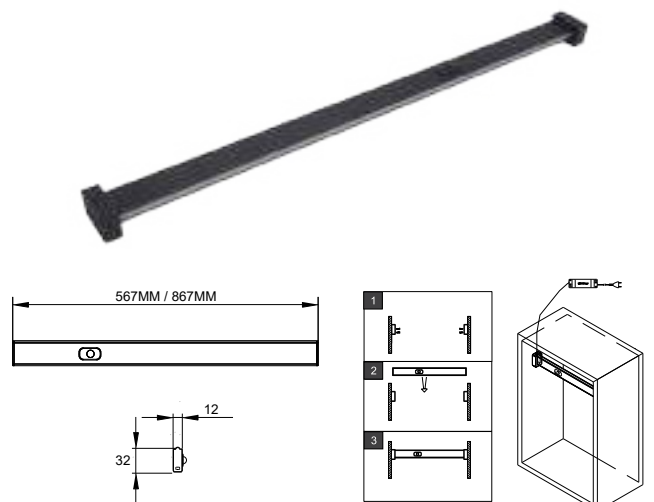

Model	Description	Carcase	Dimension (W x D x H)	Wattage	List Price
HL17116-564	HL17116-564 LED Hanging Rod PIR Sensor Light 567mm(6w) 4000K	600 mm	567mm x 12mm x 32mm	6.0 W	RM 107.00
HL17116-864	HL17116-864 LED Hanging Rod PIR Sensor Light 867mm(9w) - 4000K	900 mm	867mm x 12mm x 32mm	9.0 W	RM 129.00
HL17116-1164	HL17116-1164 LED Hanging Rod PIR Sensor Light 1167mm(12w) - 4000K	1200 mm	1167mm x 12mm x 32mm	12.0 W	RM 147.00

LIGHTING SERIES



LED GLASS SHELF LIGHTING

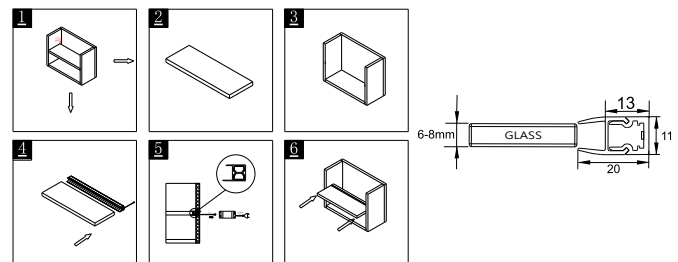

Model	Description	Carcase	Dimension (W x D x H)	Wattage	List Price
HL16113-564	HL16113-564 LED Glass Shelf Lighting 564mm(6w) - 4000K	600 mm	567mm x 28mm x 18mm	6.0 W	RM 33.00
HL16113-864	HL16113-864 LED Glass Shelf Lighting 864mm(9w) - 4000K	900 mm	867mm x 28mm x 18mm	9.0 W	RM 47.00



LED WOOD SHELF LIGHTING

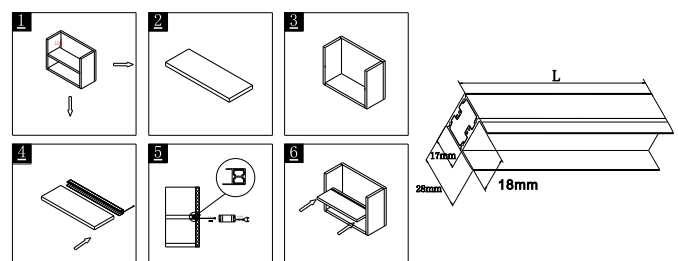

Model	Description	Carcase	Dimension (W x D x H)	Wattage	List Price
HL17112-567	HL17112-567 LED Wood Shelf Lighting 567mm(11w) - 4000K	600 mm	567mm x 28mm x 18mm	11.0 W	RM 86.00
HL17112-867	HL17112-867 LED Wood Shelf Lighting 867mm(16.5w) - 4000K	900 mm	867mm x 28mm x 18mm	16.5 W	RM 107.00



LED LIGHTING SHELF

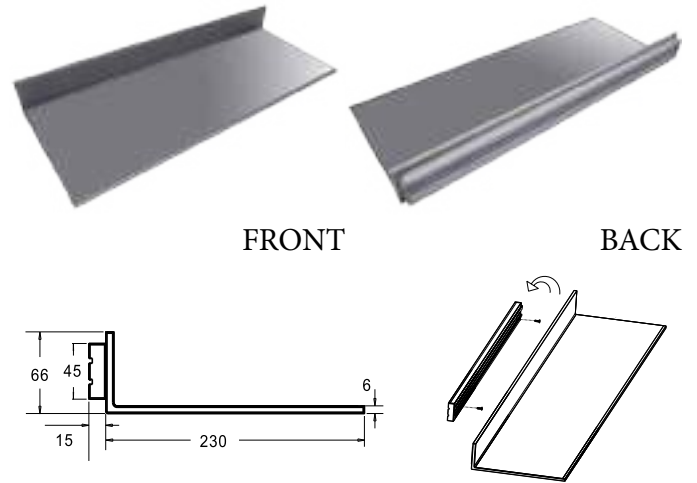

Model	Description	Carcase	Dimension (W x D x H)	Wattage	List Price
HL18131-600	HL18131-600 LED Lighting Shelf 600mm (11w) - 4000K	600 mm	600mm x 230mm x 68mm	11.0 W	RM 443.00
HL18131-900	HL18131-900 LED Lighting Shelf 900mm(16.5w) - 4000K	900 mm	900mm x 230mm x 68mm	16.5 W	RM 639.00



LED CABINET LIGHTING DUOBLE SIDE INFA-RED SENSOR

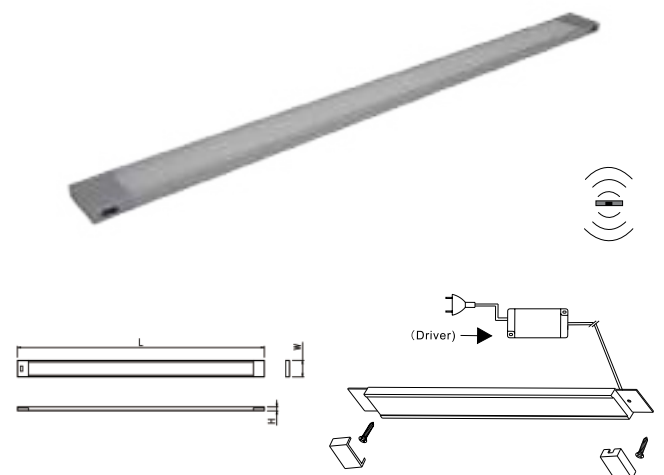

Model	Description	Carcase	Dimension (W x D x H)	Wattage	List Price
HL15108-560	HL15108-560 LED Cabinet Lighting Duoble-Side Infa-Red Sensor 560mm(5w) - 4000K	600 mm	560mm x 40mm x 9.5mm	5.0 W	RM 172.00
HL15108-860	HL15108-860 LED Cabinet Lighting Duoble-Side Infa-Red Sensor 860mm(8w) - 4000K	900 mm	860mm x 40mm x 9.5mm	8.0 W	RM 211.00

LIGHTING SERIES



CONCEAL LED LIGHT BAR PIR SENSOR

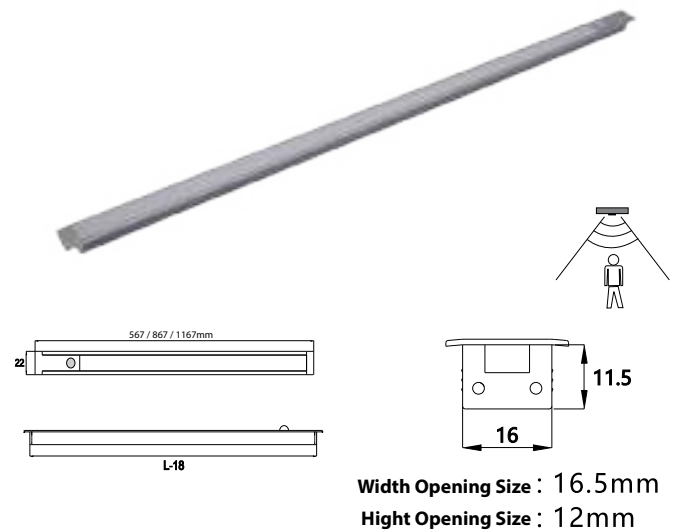

Width Opening Size : 16.5mm
High Opening Size : 12mm

Model	Description	Carcase	Dimension (W x D x H)	Wattage	List Price
HL17103-567	HL17103-567 Conceal LED Light Bar PIR Sensor 567mm(6w) - 4000K	600 mm	567mm x 22mm x 11.5mm	6.0 W	RM 92.00
HL17103-867	HL17103-867 Conceal LED Light Bar PIR Sensor 867mm(9w) - 4000K	900 mm	867mm x 22mm x 11.5mm	9.0 W	RM 106.00
HL17103-1167	HL17103-1167 Conceal LED Light Bar PIR Sensor 1167mm(12w) - 4000K	1200 mm	1167mm x 22mm x 11.5mm	12.0 W	RM 121.00



CONCEAL LED LIGHT BAR HAND SWEEP SENSOR

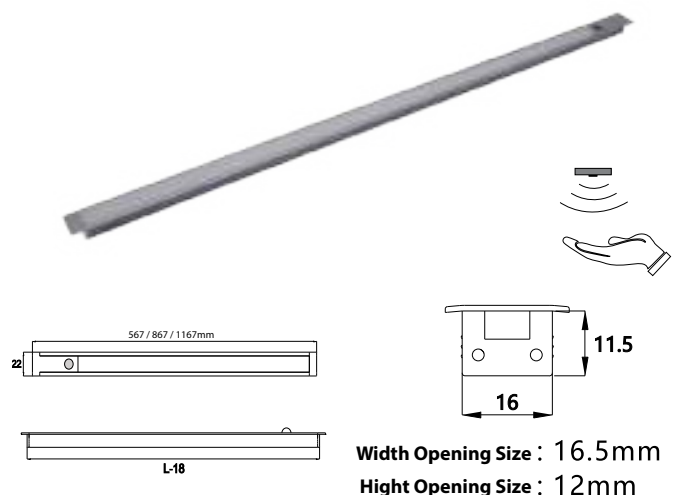

Width Opening Size : 16.5mm
High Opening Size : 12mm

Model	Description	Carcase	Dimension (W x D x H)	Wattage	List Price
HL17104-567	HL17104-567 Conceal LED Light Bar Hand Sweep Sensor 567mm(6w) - 4000K	600 mm	567mm x 22mm x 11.5mm	6.0 W	RM 92.00
HL17104-867	HL17104-867 Conceal LED Light Bar Hand Sweep Sensor 867mm(9w) - 4000K	900 mm	867mm x 22mm x 11.5mm	9.0 W	RM 106.00

CONCEAL LED LIGHT BAR

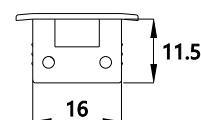
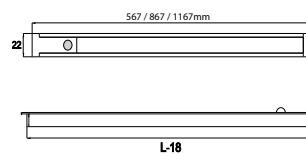

Width Opening Size : 16.5mm
Height Opening Size : 12mm

Model	Description	Carcase	Dimension (W x D x H)	Wattage	List Price
HL19107-567	HL19107-567 Conceal LED Light Bar 567mm(6w) - 4000K	600 mm	567mm x 22mm x 11.5mm	6.0 W	RM 52.00
HL19107-867	HL19107-867 Conceal LED Light Bar 867mm(9w) - 4000K	900 mm	867mm x 22mm x 11.5mm	9.0 W	RM 66.00
HL19107-1167	HL19107-1167 Conceal LED Light Bar 1167mm(12w) - 4000K	1200 mm	1167mm x 22mm x 11.5mm	12.0 W	RM 81.00
HL19107-2000	HL19107-2000 Conceal LED Light Bar 2000mm(21w) - 4000K	~	2000mm x 22mm x 11.5mm	21.0 W	RM 136.00
HL19107-2500	HL19107-2500 Conceal LED Light Bar 2500mm(26w) - 4000K	~	2500mm x 22mm x 11.5mm	26.0 W	RM 170.00
HL19107-3000	HL19107-3000 Conceal LED Light Bar 3000mm(32w) - 4000K	~	3000mm x 22mm x 11.5mm	32.0 W	RM 204.00



SURFACE LED LIGHTING BAR TRIANGLE SHAPE

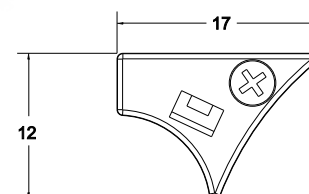
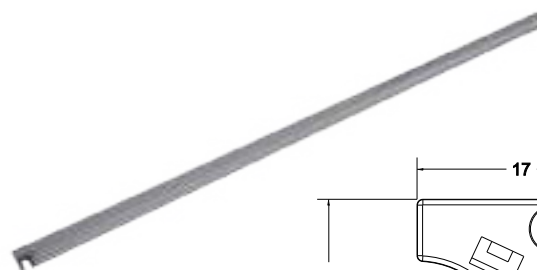

Model	Description	Carcase	Dimension (W x D x H)	Wattage	List Price
HL18117-567	HL18117-567 Surface LED Light Bar Triangle-Shape 567mm	600 mm	567mm x 22mm x 11.5mm	6.0 W	RM 62.00
HL18117-867	HL18117-867 Surface LED Light Bar Triangle-Shape 867mm	900 mm	867mm x 22mm x 11.5mm	9.0 W	RM 83.00
HL18117-1167	HL18117-1167 Surface LED Light Bar Triangle-Shape 1167mm	1200 mm	1167mm x 22mm x 11.5mm	12.0 W	RM 116.00

LIGHTING SERIES

SURFACE LED ROUND LIGHT

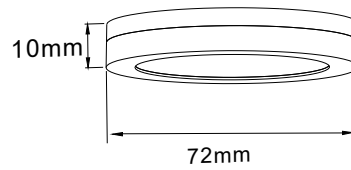

Model	Description	Dimension (W x D x H)	Wattage	List Price
HL13207	HL13207 Surface LED Round Light (2.2w) Ø72mm x 10mm 4000K	Ø72mm x 10mm	2.2 W	RM 50.00

CONCEAL LED LIGHT

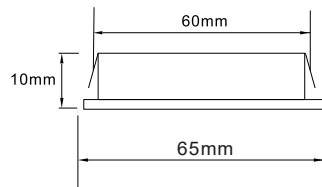

Model	Description	Dimension (W x D x H)	Wattage	List Price
HL19210	HL19210 Conceal LED Light Warm Light 4000K	Ø65mm x 10mm	1.8 W	RM 42.00

T5 LED LIGHT

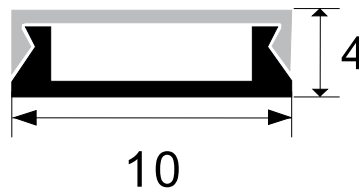

Model	Description	Dimension (W x D x H)	Wattage	List Price
HL15110-600	HL15110-600 T5 LED Light (6.5w) 4000K	600mm x 10mm x 4mm	6.5 W	RM 25.00
HL15110-900	HL15110-900 T5 LED Light (9.5w) 4000K	900mm x 10mm x 4mm	9.5 W	RM 36.00
HL15110-1200	HL15110-1200 T5 LED Light (12.5w) 4000K	1200mm x 10mm x 4mm	12.5 W	RM 49.00

LED LIGHT BELT



Model	Description	Length	Wattage	List Price
SE-L8-2835-12-30K	SE-L8-2835-12-30K 5M LED Light Belt Yellow Light 3000K	5 meter	14.0 W	RM 120.00
SE-L8-2835-12-40K	SE-L8-2835-12-40K 5M LED Light Belt Warm Light 4000K	5 meter	14.0 W	RM 120.00
SE-L8-2835-12-65K	SE-L8-2835-12-65K 5M LED Light Belt White Light 6500K	5 meter	14.0 W	RM 120.00

PIR MOVING SENSOR

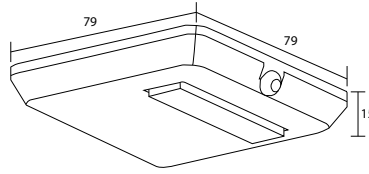
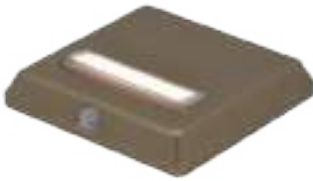

Model	Description	Dimension (W x D x H)	Wattage	List Price
L1013133	L1013133 PIR Moving Sensor LED Light - Champion	79m x 79mm x 15mm	0.5 W	RM 130.00

INFA-RED SENSOR FOR LED LIGHT

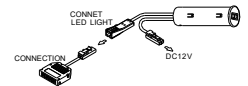
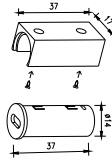
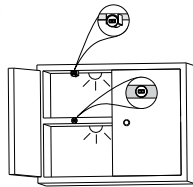

Model	Description	Dimension (W x H)	Wattage	List Price
HLGS13003	HLGS13003 Infa-red Sensor for LED Light (60w)	37mm x 17mm	24.0 W	RM 42.00
HLGS16003	HLGS16003 Infa-red Sensor for LED Light (60w)	37mm x 17mm	60.0 W	RM 74.00

HAND SWEEP SENSOR FOR LED LIGHT

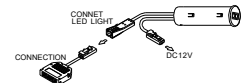
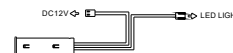
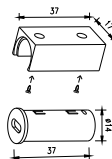
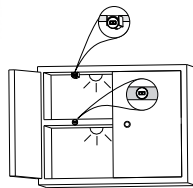

Model	Description	Dimension (W x H)	Wattage	List Price
HLGS13004	HLGS13004 Hand Sweep Sensor for LED Light (24w)	37mm x 17mm	24.0 W	RM 42.00

PIR SENSOR FOR LED LIGHT

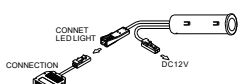
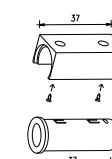
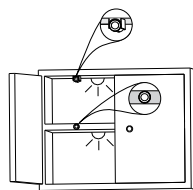

Model	Description	Dimension (W x H)	Wattage	List Price
HLGS16005	HLGS16005 PIR Sensor for LED Light (24w)	37mm x 17mm	24.0 W	RM 45.00

LIGHTING SERIES

SEMICIRCLE-SHAPE WIRE TRUKING



Model	Description	Dimension (L)	Wattage	List Price
HL002	HL002 Semicircle-Shape Wire Trunking 1000mm	1000 mm	~	RM 7.00

TRIANGLE-SHAPE WIRE TRUNKING

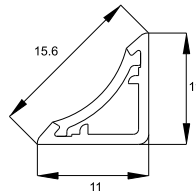

Model	Description	Dimension (L)	Wattage	List Price
HL003	HL003 Triangle-Shape Wire Trunking 1000mm	1000 mm	~	RM 7.00

LED STRIP CONNECTION



Model	Description	Dimension (L)	Wattage	List Price
HLDC03	HLDC03 LED Strip Connection	1.50 meter	~	RM 7.00

LIGHTING CONNECTION



Model	Description	Dimension (W x D x H)	Wattage	List Price
HLGSBOX609-4	HLGSBOX609-4 Lighting Connection (4 Hole)	~	~	RM 9.00

WIREDLESS CONTROLLER



Model	Description	Dimension (W x D x H)	Wattage	List Price
HLGS17009	HLGS17009 LED Wireless Controller - Black	~	~	RM 45.00

WIREDLESS RECEIVER



Model	Description	Dimension (W x D x H)	Wattage	List Price
HLGS17013	HLGS17013 LED Wireless Receiver 60w - Black	~	60 W	RM 49.00

LED DRIVER

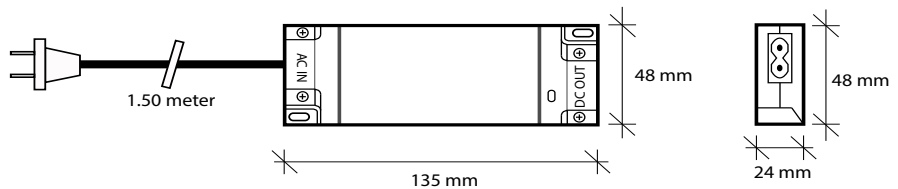

Model	Description	Dimension (W x D x H)	Wattage	List Price
LED16001	LED16001 LED Driver 15 W	135mm x 48mm x 24mm	15.0 W	RM 50.00
LED15015	LED15015 LED Driver 30 W	135mm x 48mm x 24mm	30.0 W	RM 68.00
LED15016	LED15016 LED Driver 60 W	135mm x 48mm x 24mm	60.0 W	RM 129.00

MUSE
Kitchen



WARDROBE SYSTEM



**SOFT CLOSE
DECORATION SHELF**

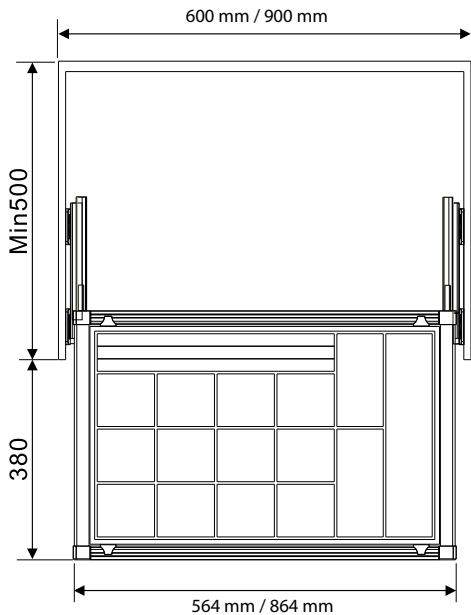

Model	Description	Carcase	Dimension (W x D x H)	Finishing	List Price
WAH2106G-600	WAH2106G-600mm Soft Close Decorations Shelf 600mm	600 mm	564mm x 478mm x 73mm	Dark Gray	RM 495.00
WAH2106G-900	WAH2106G-900mm Soft Close Decorations Shelf 900mm	900 mm	864mm x 478mm x 73mm	Dark Gray	RM 625.00



SOFT CLOSE TROUSER RACK

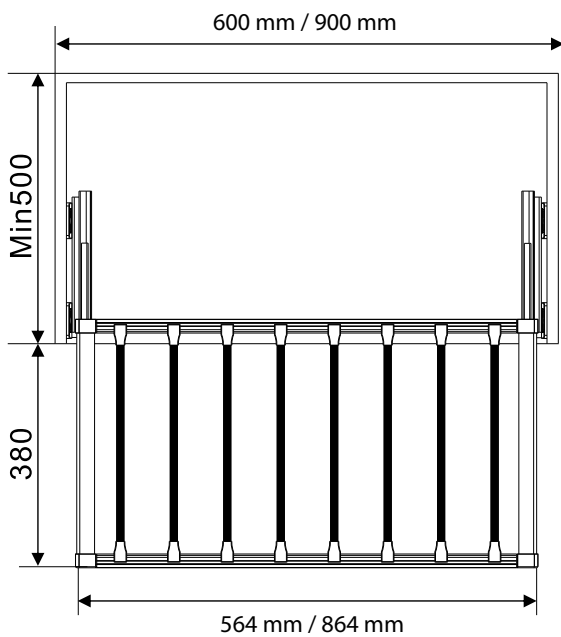

Model	Description	Carcase	Dimension (W x D x H)	Finishing	List Price
WAH2177G-600	WAH2177G-600mm Soft Close Trousers Rack 600mm	600 mm	564mm x 478mm x 73mm	Dark Gray	RM 310.00
WAH2177G-900	WAH2177G-900mm Soft Close Trousers Rack 900mm	900 mm	864mm x 478mm x 73mm	Dark Gray	RM 355.00



**SOFT CLOSE
GLASS STORAGE RACK**

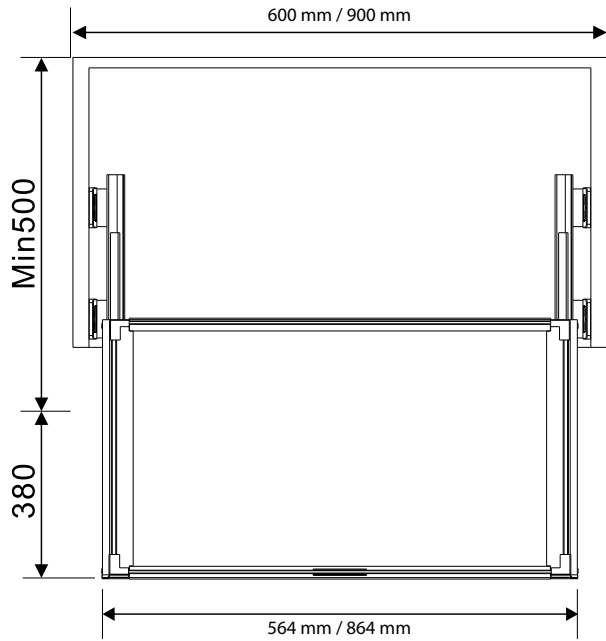

Model	Description	Carcase	Dimension (W x D x H)	Finishing	List Price
WAH2108G-600	WAH2108G-600mm Soft Close Storage Rack 600mm	600 mm	564mm x 478mm x 73mm	Dark Gray	RM 390.00
WAH2108G-900	WAH2108G-900mm Soft Close Storage Rack 900mm	900 mm	864mm x 478mm x 73mm	Dark Gray	RM 465.00

WARDROBE SYSTEM



SOFT CLOSE STORAGE RACK

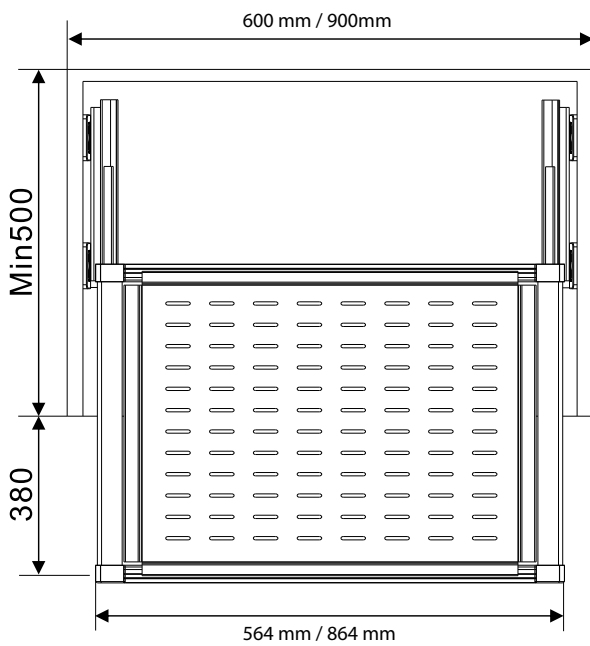

Model	Description	Carcase	Dimension (W x D x H)	Finishing	List Price
WAH2101G-600	WAH2101G-600mm Soft Close Storage Rack 600mm	600 mm	564mm x 478mm x 73mm	Dark Gray	RM 415.00
WAH2101G-900	WAH2101G-900mm Soft Close Storage Rack 900mm	900 mm	864mm x 478mm x 73mm	Dark Gray	RM 490.00



**SOFT CLOSE
STORAGE RACK**

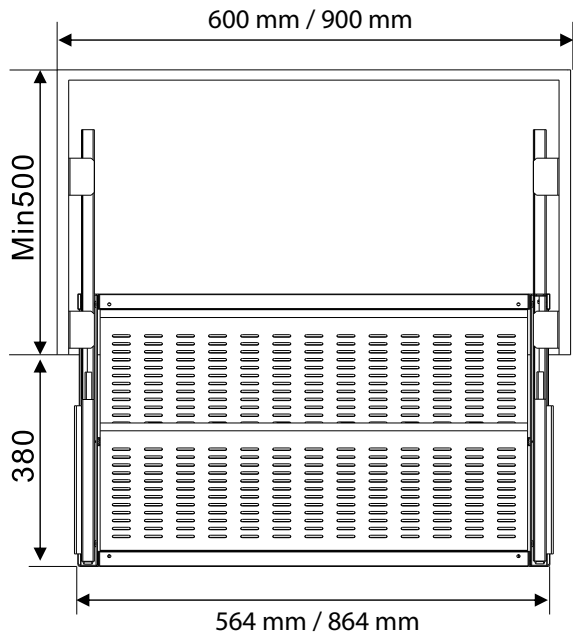

Model	Description	Carcase	Dimension (W x D x H)	Finishing	List Price
WAH2104G-600	WAH2104G-600mm Soft Close Shoe Rack 600mm	600 mm	564mm x 478mm x 73mm	Dark Gray	RM 410.00
WAH2104G-900	WAH2104G-900mm Soft Close Shoe Rack 900mm	900 mm	864mm x 478mm x 73mm	Dark Gray	RM 490.00



SOFT CLOSE TOP PANTS RACK

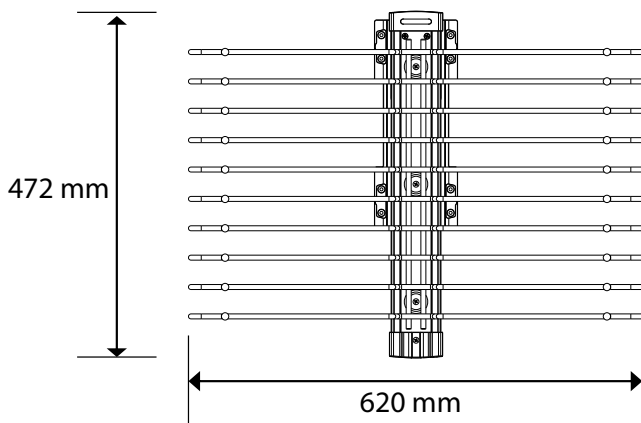

Model	Description	Carcase	Dimension (W x D x H)	Finishing	List Price
WAH2103	WAH2103 Top Pants Rack	800 mm	620mm x 472mm x 135mm	Chaco	RM 300.00



**SOFT CLOSE
COAT HANGER**

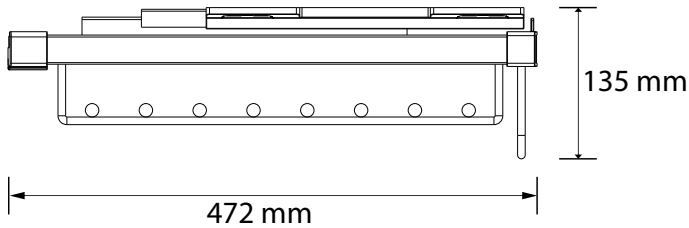

Model	Description	Carcase	Dimension (W x D x H)	Finishing	List Price
WAH2109	WAH2109 Single Extension Slide Coat Hanger	600 mm	113mm x 472mm x 135mm	Chaco	RM 175.00



FITTING ACCESSORIES

ALUMINIUM ROLLER SHUTTER



Model	Description	Carcase Size (W x H)	Finishing	List Price
RS600*1200	Roller Shutter Alum.W600*H1200mm	600mm x 1200mm	Champagne	RM 900.00
RS900*1200	Roller Shutter Alum.W900*H1200mm	900mm x 1200mm	Champagne	RM 1000.00
RS600*1500	Roller Shutter Alum.W600*H1500mm	600mm x 1500mm	Champagne	RM 1000.00
RS900*1500	Roller Shutter Alum.W900*H1500mm	900mm x 1500mm	Champagne	RM 1100.00

PLATE HOLDER

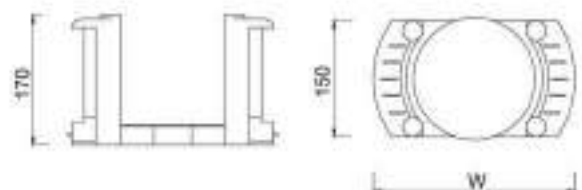
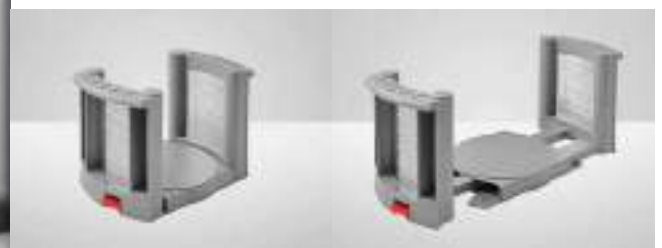

Model	Description	Adjustment Size (W)	Finishing	List Price
4043 108 001	PH29888 Plate Holder	183mm - 320mm	Grey	RM 85.00

SQUARE WASTE BIN

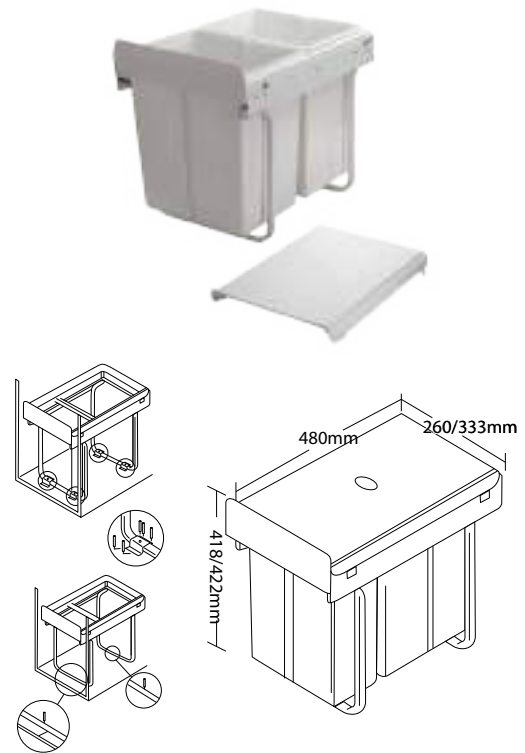

Model	Description	Dimension (W x D x H)	Carsase	List Price
4043 001 030	T3101 Waste Bin 300mm	260mm x 480mm x 418mm	300mm	RM 365.00
4043 001 040	T3102 Waste Bin 400mm	333mm x 480mm x 422mm	400mm	RM 410.00

ROUND WASTE BIN



Model	Description	Dimension (W x H)	Carsase	List Price
4043 003 002	T3111 Built in Waste Bin S/Steel Small 8 liter	275mm x 245mm	~	RM 98.00
4043 005 001	T3115 Waste Bin Black 15 liter	300mm x 340mm	~	RM 125.00

EASY LIFT UP STAY

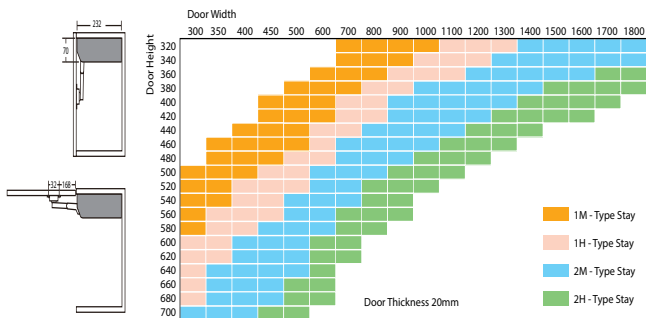

Model	Description	Dimension (W x D x H)	Finishing	List Price
4045 017 001	Easy Lift up stay (748280) Left	~	Grey	RM 50.00
4045 017 002	Easy Lift up stay (748280) Right	~	Grey	RM 50.00

DOOR HANGER



Model	Description	List Price
4045 107 000	LS3107 Door Hanger	RM 100.00

GAS SPRING



Model	Description	List Price
4045 008 008	Gas Spring 100N	RM 12.00

SINK BOTTOM PROTECT

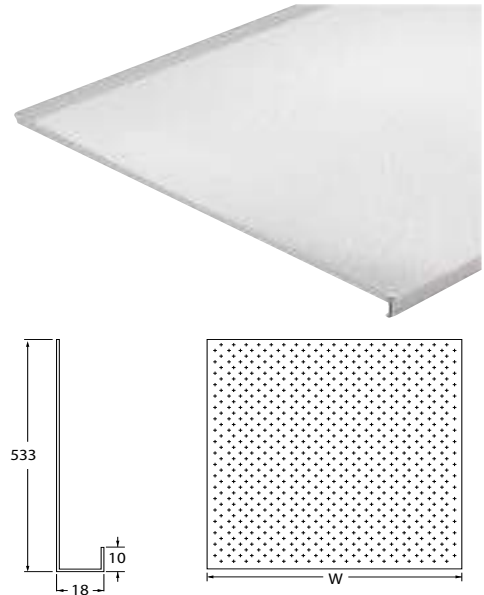
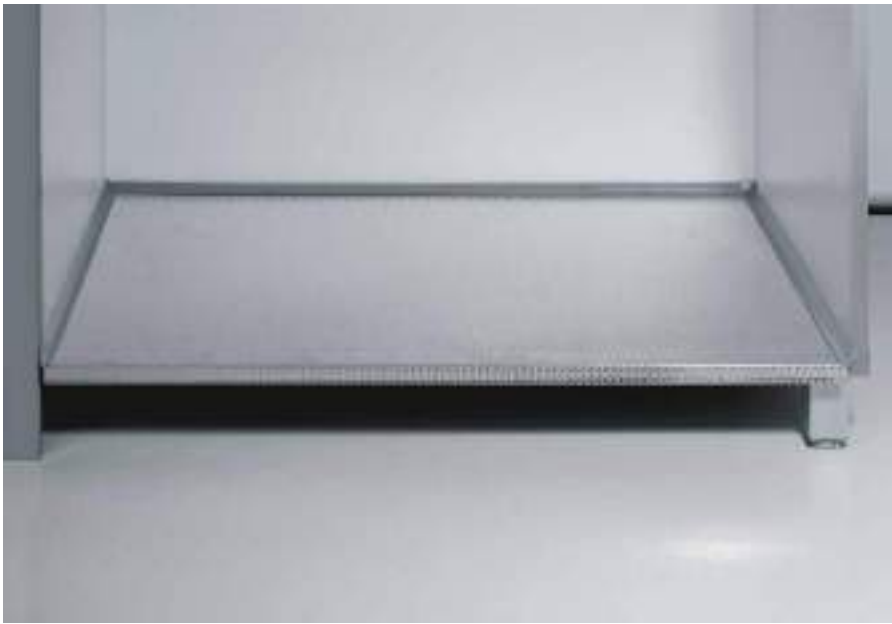

Model	Description	Dimension (W x D x H)	Carsase	List Price
4043 020 060	567 Sink Alum. Bottom Protector 600mm	567mm x 533mm x 18mm	600mm	RM 80.00
4043 020 080	767 Sink Alum. Bottom Protector 800mm	767mm x 533mm x 18mm	800mm	RM 104.00
4043 020 090	867 Sink Alum. Bottom Protector 900mm	867mm x 533mm x 18mm	900mm	RM 113.00
4043 020 100	967 Sink Alum. Bottom Protector 1000mm	967mm x 533mm x 18mm	1000mm	RM 126.00
4043 020 120	1167 Sink Alum. Bottom Protector 1200mm	1167mm x 533mm x 18mm	1200mm	RM 148.00

SINK BOTTOM PROTECT

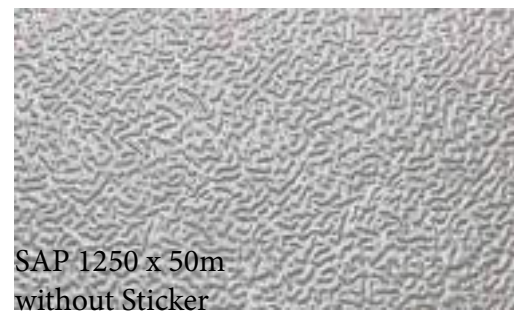

Model	Description	Dimension (T x H x L)	Carsase	List Price
SSA1220*50m	Sticker Sink Alum. Bottom Protector 1220*50	0.1mm x 1220mm x 50m	~	RM 880.00
SAP1250*50m	Sink Alum. Bottom Protector	0.13mm x 1250mm x 50m	~	RM 1675.00

KITCHEN LEG

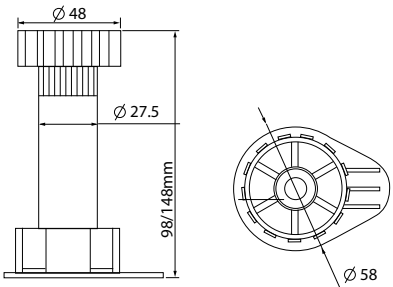
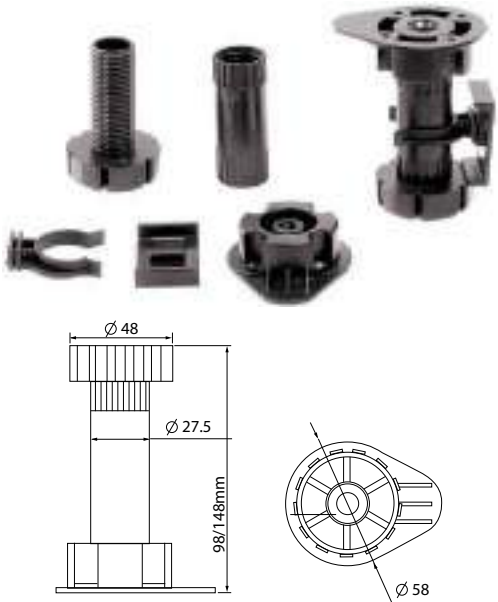

Model	Description	Dimension (D x H)	Finishing	List Price
4043 010 011	Kitchen Leg 4" Black ABS 100mm	Ø 48 x 95mm	Black	RM 6.00
4043 010 012	Kitchen Leg 6" Black ABS 150mm	Ø 48 x 145mm	Black	RM 7.00

VENTILATOR COVER

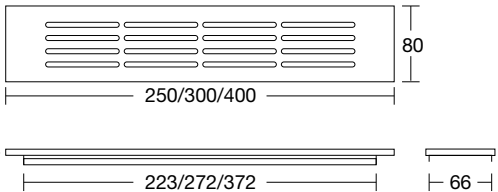

Model	Description	Dimension (W x D)	Material	List Price
4043 018 025	WH250mm Ventilator Cover Alum.	80mm x 250mm	Aluminium	RM 12.00
4043 018 030	WH300mm Ventilator Cover Alum.	80mm x 300mm	Aluminium	RM 15.00
4043 018 040	WH400mm Ventilator Cover Alum.	80mm x 400mm	Aluminium	RM 20.00

CABINET SKIRTING

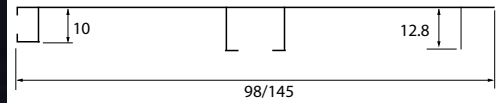

Model	Description	Dimension (L x H)	Material	List Price
4043 100 010	451-100mm*4m Cabinet Skirting 100mm	4m x 100mm	PVC	RM 53.00
4043 100 015	451-150mm*4m Cabinet Skirting 100mm	4m x 150mm	PVC	RM 85.00

CABINET SKIRTING CORNER CONECTION

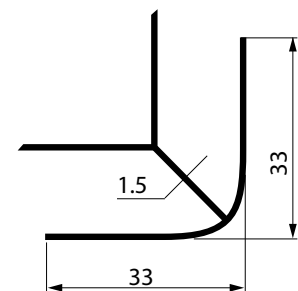

Model	Description	Dimension (W x D x H)	Material	List Price
4043 101 010	452-100mm Skirting Corner 90 °	33mm x 33mm x 100mm	PVC	RM 4.00
4043 101 015	452-150mm Skirting Corner 90 °	33mm x 33mm x 150mm	PVC	RM 6.00

HYDROULIC HINGE

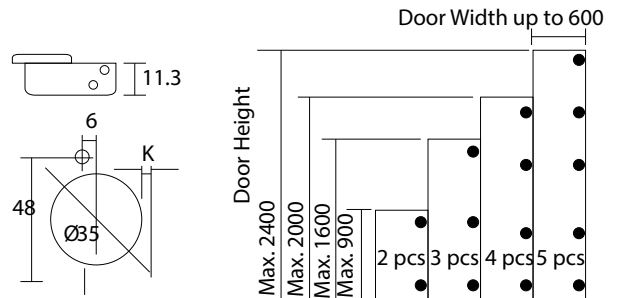

Model	Description	Dimension (L x H)	Material	List Price
4041 001 001	HUASS SC110-16 CO Hydraulic Hinge - Clip On	~	~	RM 3.50
4041 001 003	HUASS SC110-16 SI Hydraulic Hinge - Slide In	~	~	RM 3.00

DOOR TOUCH OPEN CATCH



Model	Description	Dimension (L)	Material	List Price
4041 002 001	Door Touch Open Catch	84mm - 124mm	PVC	RM 4.80

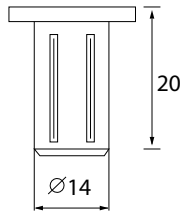

Model	Description	Finishing	List Price
4042 001 000	H09001 End Cap 173065	PVC/Chrome	RM 12.00

TUBE HOLDER CONNECTOR

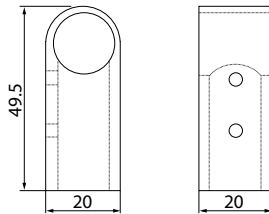

Model	Description	Finishing	List Price
4042 002 000	H09002 Tube Holder Connector	Chrome	RM 18.00

TUBE

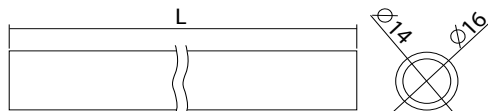

Model	Description	Finishing	List Price
4042 003 060	E11060 16mm,600mm Tube	Chrome	RM 30.00
4042 003 090	E11090 16mm,900mm Tube	Chrome	RM 36.00
4042 003 120	E11120 16mm,1200mm Tube	Chrome	RM 42.00

S-HOOK

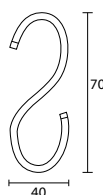

Model	Description	Finishing	List Price
4042 003 000	H29025 S-Hook (5pcs/bag)	S/Steel	RM 36.00

HANGING HOLDER

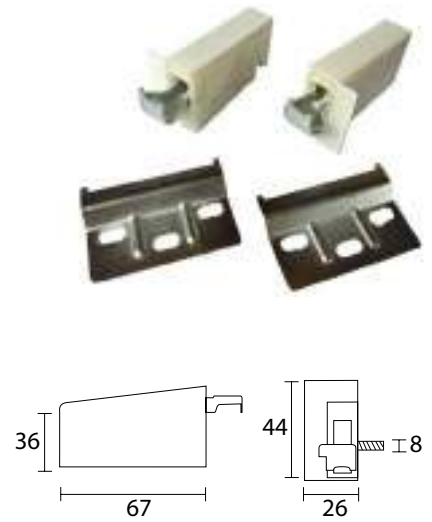

Model	Description	Dimension (W x D x H)	Material	List Price
4043 106 002	Hanging Holder V	26mm x 67mm x 44mm	PVC	RM 6.50

RUBBER MAT



Model	Description	Dimension (T x D x L)	Material	List Price
4043 009 000	Rubber Mat (T)0.5mm x 505mm(D) x 10 meter(L)	0.50mm x 505mm x10meter	~	RM 365.00

HD138 C HANDLE

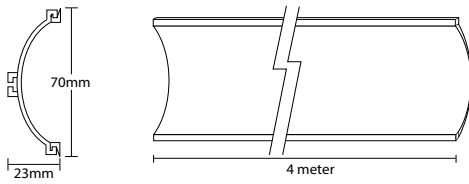

Model	Description	Material	List Price
HD138C*4	138 x 4.05m C Handle EV3878	Aluminium	RM 150.00

HD139 L HANDLE

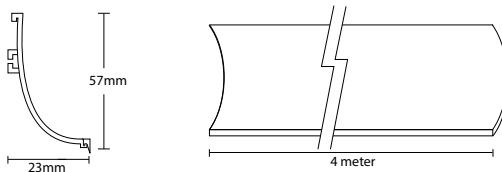

Model	Description	Material	List Price
HD139L*4	139 x 4.05m L Handle EV3877	Aluminium	RM 120.00

HD118 C HANDLE

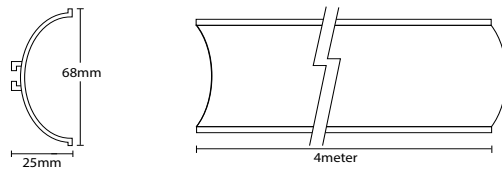

Model	Description	Material	List Price
HD118C*4	118 x 4.05m C Handle EV1683	Aluminium	RM 90.00

HD119 L HANDLE

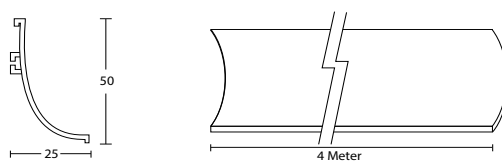

Model	Description	Material	List Price
HD119L*4	119 x 4.05m L Handle EV1683	Aluminium	RM 65.00

L Bracket



Model	Description	Material	List Price
HDB-N	Bracket Metal for handle C/L Channel	Matel	RM 1.50

HD0234 HANDLE

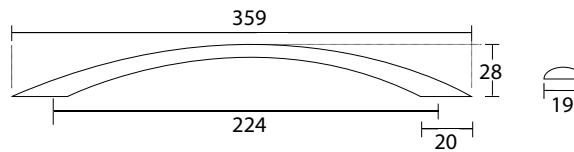

Model	Description	Finishing	List Price
HD0234224AL	0234-224 Aluminium Handle	AL	RM 21.00
HD0234224SN	0234-224 Satin Nickel Handle	SN	RM 22.00

HD0288 HANDLE

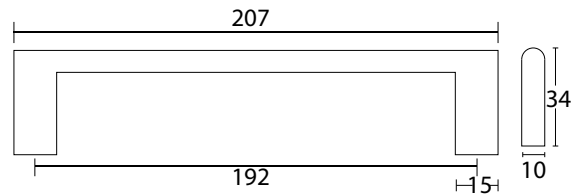

Model	Description	Finishing	List Price
HD0288192	0288-192mm Zinc Alloy Handle	SN	RM 24.00

HD0290 HANDLE

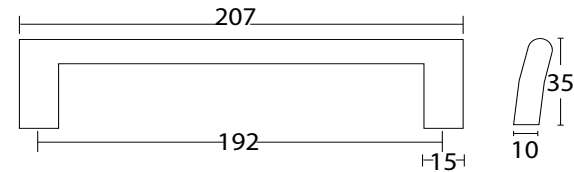

Model	Description	Finishing	List Price
HD0290192	0290-192mm Zinc Alloy Handle	SN	RM 25.00

HD301 HANDLE

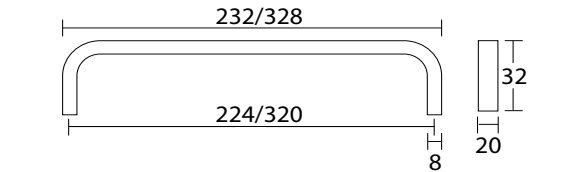

Model	Description	Finishing	List Price
HD0301224	A301-224mm Aluminium Handle	AL	RM 13.00
HD0301320	A301-320mm Aluminium Handle	AL	RM 17.00

HD471 HANDLE

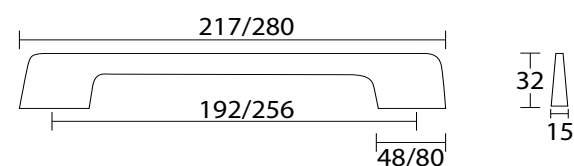

Model	Description	Finishing	List Price
HD471192SS	471-192mm Brush SS Handle	BSS	RM 29.00
HD471256SS	471-256mm Brush SS Handle	BSS	RM 35.00

HD478 HANDLE

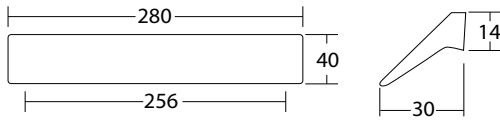

Model	Description	Finishing	List Price
HD478256SS	478-256mm Brush SS Handle	BSS	RM 31.00

HD6228 HANDLE

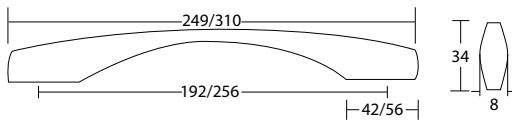

Model	Description	Finishing	List Price
HD6228192BSNM	6228-192mm BSN Matt Handle	BSS	RM 25.00
HD6228256BSNM	6228-256mm BSN Matt Handle	BSS	RM 30.00

HD6229 HANDLE

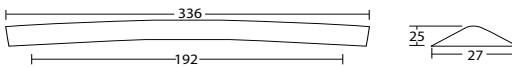

Model	Description	Finishing	List Price
HD6229192BSNM	6229-192mm BSN Matt Handle	BSS	RM 26.00

HD6253 HANDLE

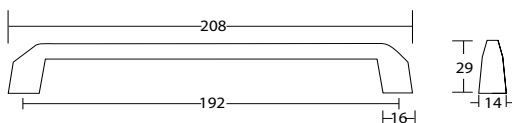

Model	Description	Finishing	List Price
HD6253192BSNM	6253-192mm BSN Matt Handle	BSS	RM 26.00

HD6254 HANDLE

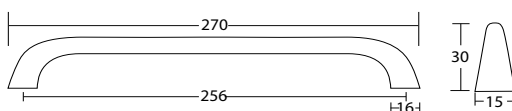

Model	Description	Finishing	List Price
HD6254256BSNM	6254-256mm BSN Matt Handle	BSS	RM 28.00

HD6805 HANDLE



Model	Description	Finishing	List Price
HD6805192BO	6805E-192 Brushed Oxidized Alum Handle	BO	RM 28.00
HD6805320BO	6805E-320 Brushed Oxidized Alum Handle	BO	RM 40.00

HD722 HANDLE

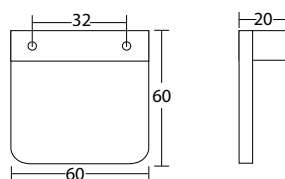

Model	Description	Finishing	List Price
HD72232SN	722-32mm BSN Handle	SN	RM 16.50
HD72232SC	722-32mm SC Handle	SC	RM 15.50

HD743B HANDLE

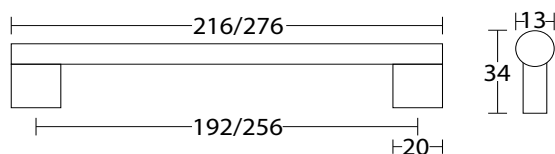

Model	Description	Finishing	List Price
HD743192AL	743B-192mm Aluminium Handle	AL	RM 14.50

HD2231 HANDLE

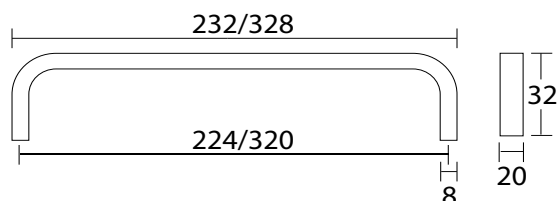

Model	Description	Finishing	List Price
HD2231192AL	2231-192mm OS Aluminium Handle	OS	RM 29.00
HD2231320AL	2231-320mm OS Aluminium Handle	OS	RM 43.00
HD2231480AL	2231-480mm OS Aluminium Handle	OS	RM 64.00
HD2231736AL	2231-736mm OS Aluminium Handle	OS	RM 95.00
HD2231192BSS	2231-192mm Brush SS Handle	BSS	RM 40.00
HD2231320BSS	2231-320mm Brush SS Handle	BSS	RM 64.00
HD2231480BSS	2231-480mm Brush SS Handle	BSS	RM 91.00
HD2231736BSS	2231-736mm Brush SS Handle	BSS	RM 142.00

HD751 HANDLE

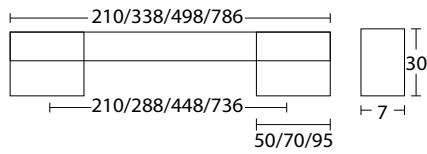

Model	Description	Finishing	List Price
HD751160AL	751A-160mm Aluminium Handle	AL	RM 18.00
HD751288AL	751A-288mm Aluminium Handle	AL	RM 32.00
HD751448AL	751A-448mm Aluminium Handle	AL	RM 42.00
HD751736AL	751A-736mm Aluminium Handle	AL	RM 68.00



HD738 HANDLE

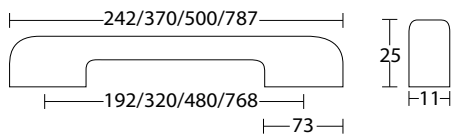

Model	Description	Finishing	List Price
HD738192AL	738-192mm Aluminium Handle	AL	RM 17.50
HD738320AL	738-320mm Aluminium Handle	AL	RM 26.00
HD738480AL	738-480mm Aluminium Handle	AL	RM 42.50
HD738768AL	738-768mm Aluminium Handle	AL	RM 68.00



HD745 HANDLE



Model	Description	Finishing	List Price
HD745224AL	745A-224mm Aluminium Handle	AL	RM 24.00
HD745320AL	745A-320mm Aluminium Handle	AL	RM 33.00
HD745224SN	745A-224mm Satin Nickel Handle	SN	RM 37.00
HD745320SN	745A-320mm Satin Nickel Handle	SN	RM 42.00



HD2311 HANDLE

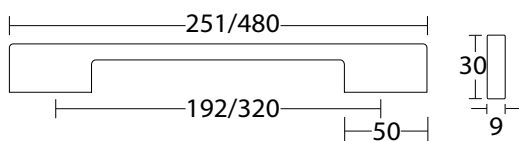

Model	Description	Finishing	List Price
HD2311192AL	2311-192mm OS Aluminium Handle	OS	RM 22.00
HD2311320AL	2311-320mm OS Aluminium Handle	OS	RM 33.00
HD231119SN	2311-192mm Satin Nickel Handle	SN	RM 30.00
HD2311320SN	2311-320mm Satin Nickel Handle	SN	RM 45.00





Muse Kitchen

002476063-D

No. 17, Jalan KP 1/1, off, Jalan Semenyih,
Taman kajang prima,

43000, Selangor Darul Ehsan, Malaysia

HP: 016-2080826(Hotline)

Fax: 03-90766657 (Finance) / 03-90766657 (Sales)

Email: musekitchen101@gmail.com

Web: www.musekitchen.com